

Desktop Card Printers:

Installation Guide

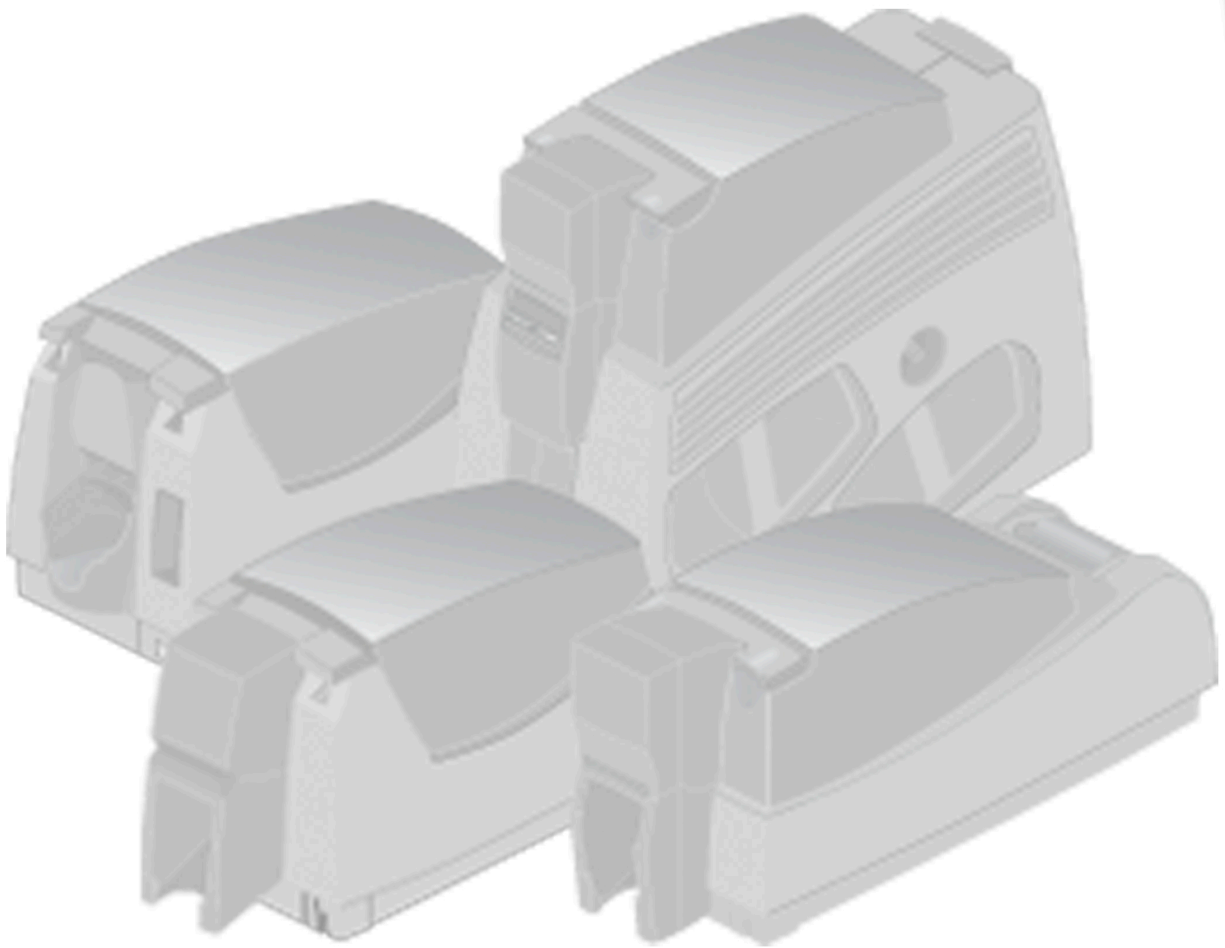

August 2011
539808-001 Rev B

Acknowledgements

CandelaColor is a registered trademark of Pictographics International Corporation.

Citrix is a registered trademark of Citrix Systems, Inc.

The Common UNIX Printing System, CUPS, and the CUPS logo are the trademark property of Easy Software Products.

Datacard is a registered trademark of DataCard Corporation in the United States and/or other countries. The color blue with platinum flecks mark is a registered trademark of DataCard Corporation in the United States, the European Union and/or other countries. UltraGrafix is a registered trademark of DataCard Corporation in the United States, the European Union and/or other countries.

HP and Jetdirect are registered trademarks of Hewlett Packard Development Company.

Linux is a registered trademark of Linus Torvalds.

Microsoft, Windows, Windows NT, and Windows Vista are registered trademarks of Microsoft Corporation.

All other trademarks are the property of their respective owners.

Names and logos on sample cards are fictitious. Any similarity to actual names, trademarks, or trade names is coincidental.

The design and information contained in these materials are protected by U.S. and international copyright law.

About Web sites in this manual

Any third-party Web site addresses and/or links contained herein are provided for informational purposes only and may change at any time without notice. We offer no warranties, express or implied, as to the quality of such third party products or tools, or to the accuracy or completeness of the information contained on or related to such Web sites.

Contents

Introduction	1
Desktop Card Printers	1
About this Manual	1
For More Information	2
Driver Co-existence on Windows	3
Should you install?	3
Driver Support for Printers	3
Older and Newer Drivers	4
Before You Install	5
Installation Requirements	5
Choosing Your Installation Method	8
Preparing the Printer	10
Installation on Windows	17
Installing the Driver with Bidirectional Communication	18
Installing More than One Printer on a PC	30
Wireless Network Connection	32
Printing Cards Using Bidirectional Communication	38
Unidirectional Printing	39
Installing the Unidirectional Driver	39
Printing Cards in the Windows Terminal Services Environment	52
Installation Troubleshooting	53
Printer Pooling	56
Requirements for a Printer Pool	56
Set up Printer Pooling	57
Printing Cards Using a Printer Pool	59
Shared Printers	62
Setting up Printer Sharing	63
Printing Cards Using a Shared Printer	70
Updating the Driver When Sharing Printers	72
Installation on Non-Windows Platforms	73
Open Platform Driver Installation	73
Open Card Installation	73
Updates, Upgrades, and More	75
Updates	75
Upgrades	78
Deviations	79
Removing a Printer from a Windows PC	79

Introduction

This manual describes all the methods available for installing desktop card printers.

Desktop Card Printers

Desktop card printers apply personalization to plastic cards. Personalization includes printing, encoding magnetic stripe data, and reading or programming smart cards. Some printers also have one or two laminators, which apply a protective layer to cards.

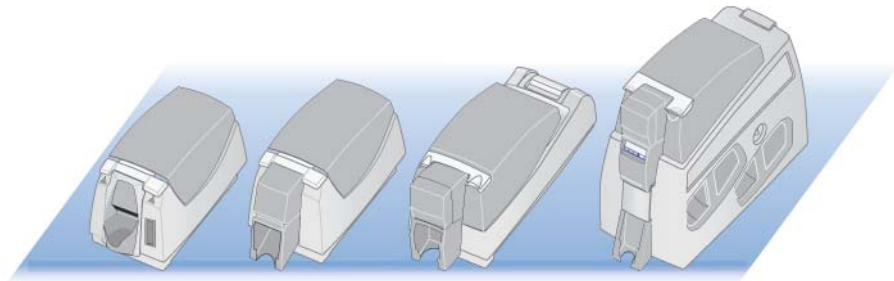

A desktop card printer is a self-contained unit that receives data from a PC (or other computer), personalizes the card using the data, and ejects the card. Desktop card printers have one or two cards in them at a time, and are designed to issue cards where the user is, called on-demand printing or instant issuance.

About this Manual

This manual applies to desktop card printers and describes:

- Windows driver support, primarily the 4.x Card Printer Driver with references to drivers up to version 12.x.
- Driver coexistence on Windows operating systems, focusing on the 12.x driver
- Preparing the printer for installation
- Windows installation

This manual is intended for anyone installing the desktop card printer. However, some procedures require a higher level of technical knowledge or experience. The following icons can guide you when choosing whether to perform a procedure yourself or to ask for assistance.



Operator: The green icon represents the Operator, who uses the printer to create cards and works at the direction of others in the organization.



Administrator: The tan icon represents the Administrator, who has responsibility for the system within the organization. The Administrator supervises the Operator in most cases.



Service Provider: The blue icon represents the Service Provider, who has training and experience to solve many problems and to perform advanced setup tasks.

For More Information . . .

The following information is available to help you use the desktop card printer:

- The *Quick Install Guide* is packaged in the carton with the printer. For the Kiosk Printer, a *Quick Reference Guide* is packaged in the carton. For most printers, the *Quick Install Guide* is posted on the Web site.
- This manual, the *Desktop Card Printers: Installation Guide* (539808-001) is available from the Web site. It provides detailed information for all installation choices.
- For users of the Windows Card Printer Driver, *InfoCentral* is installed when the driver is installed. You can open it using the shortcut in the Start > Programs menu. *InfoCentral* is also available on the driver CD without installing the driver.
- For users of the Open Platform Driver, the download package for the driver includes the online *Printer Guide* (539642-001).
- For users of the Open Card format, the Open Card Option CD-ROM (558868-001) includes a *Printer Guide* (539398-001).
- The printhead is user replaceable. Replacement printheads include instructions (539295-001) for replacing the printhead.
- A Firmware Update Program is available to use with the Windows Card Printer Driver and a firmware file. The download for the Firmware Update Program includes instructions (539745-001).
- The *Solutions Guide* (539707-001) provides detailed information for integrators. The *Solutions Guide* can be downloaded from the service Web site.



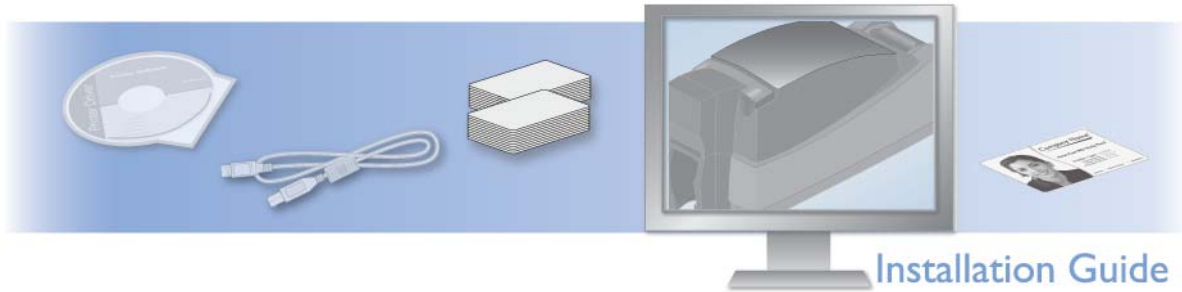

Driver Co-existence on Windows

This chapter provides information about installing more than one driver on a PC. It describes:

- "Should you install?"
- "Driver Support for Printers"
- "Older and Newer Drivers" on the same PC

Should you install?



If a card printer is installed that uses a driver with a version of 7.7 or lower, remove the printer and driver before installing the current printer on the PC. Follow instructions provided with that driver to completely remove it. You can install the printer again with a current driver.

Only Card Printer Drivers with the same brand can be installed on the same PC. The brand includes the manufacturer and product line.

The 2.x printer driver is compatible with drivers of the same brand with versions of 7.4, 7.5, 7.6, 7.7, and 1.0. (Not all brands have all versions of the printer driver.) Compatible drivers can be installed on the same PC.

Driver Support for Printers

Printer serial numbers correspond with driver releases. Match the serial number of your printer to the driver release that supports it.

Serial Number	Windows® 98, Me, or NT 4.0 [#]	Windows 2000	Windows XP or Server 2003	Windows Vista® or Windows Server 2008	Windows 7
above 90001	Not supported	Card Printer Driver 2.x	Card Printer Driver 2.x and 4.x	Card Printer Driver 3.x and 4.x	Card Printer Driver 12.x
70001 to 90000	Driver 7.4 to 7.7	Driver 7.4 to 7.7	Driver 7.4 to 7.7 Card Printer Driver 4.x	Card Printer Driver 3.x and 4.x	Card Printer Driver 12.x
below 70000	Driver 7.4 to 7.7	Driver 7.4 to 7.7	Driver 7.4 to 7.7 Card Printer Driver 4.x	Card Printer Driver 3.x and 4.x	Card Printer Driver 12.x

[#]. Windows NT® 4.0 is supported only for a network connection to the printer. Windows NT does not support USB connection between the printer and PC.

Older and Newer Drivers

Some drivers can be installed on the same PC along with other drivers. On Windows 2000, Windows XP, or Windows Server 2003, the following pairs can be installed on the same PC.

- Driver 7.4 and Card Printer Driver 12.0
- Driver 7.5 and Card Printer Driver 12.1
- Driver 7.4 and Card Printer Driver 2.0
- Driver 7.5 and Card Printer Driver 2.1
- Driver 7.6 and Card Printer Driver 2.2
- Driver 7.7 and Card Printer Driver 2.3

If the printer is installed with a 7.x driver and you want to install a new printer that uses the 12.x driver, do the following:

- Delete the 7.x driver (in the printers window)
- Run the Cleanup Utility to remove 7.x driver files
- Remove any folder to which the 7.x files were extracted
- Remove the 7.x driver CD from the PC
- Install both printers with the 12.x driver

Windows 2000 is not supported by the 4.x, 5.x, 10.x, or 12.x printer drivers.

If the printer is installed with the 1.x driver, delete the driver and install the printer with the 12.x driver. See "[Shared Printers](#)" for information about updating when using printer sharing.

During driver installation, the installation detects the earlier version (1.0, 2.x, or 3.x) and prompts you to update the existing driver before installing the new version. After updating the existing driver, start installation again to install the new printer with the 4.x driver.

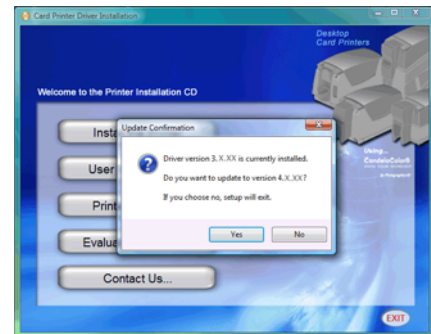

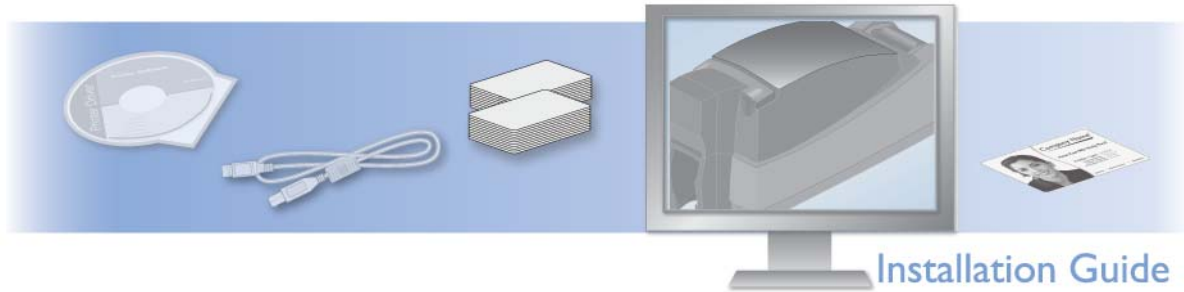

Before You Install

This section describes:

- Installation requirements
- Choosing your installation method
- Preparing the printer for installation

Installation Requirements

PC Requirements



Use a PC that meets or exceeds the following:

- A 32- or 64-bit processor, running at 2 GHz or faster
- Memory (RAM):
 - 1 GB or more for Windows XP
 - 2 GB or more for Windows 7 and Windows Vista
- At least 15 GB free space on the hard drive
- One of the following operating systems with latest service pack installed.
 - 32-bit:
 - ◁ Windows 7
 - ◁ Windows Vista®
 - ◁ Windows XP
 - ◁ Windows 2003 Server
 - ◁ Windows 2008 Server
 - 64-bit:
 - ◁ Windows 7
 - ◁ Windows Vista®
 - ◁ Windows 2003 Server
 - ◁ Windows 2008 Server
- USB port or Ethernet network connection

If the printer does not have a built-in Ethernet port and you plan to use a direct network connection, you also need a print server.

- ID software to capture and organize the data to appear on each card.

Requirements for a Direct Network Connection



To install a printer using the Built-in Ethernet option, the following components are required:

- An Ethernet network that uses the TCP/IP protocol and can run at 100 megabits per second, also called 100base-T. Printers also support 10base-T.
- A printer equipped with the Built-in Ethernet feature OR a print server. The HP® Jetdirect® 175x, revision C, print server has been tested.
- An Ethernet cable to connect the printer to the network. No Ethernet cable is supplied with the printer.
- A PC that meets the requirements listed above, that is connected to and communicating with the network.
- You can connect up to 20 directly networked printers to one PC. If you need to install more than 20 printers on one PC, contact your service provider for assistance.

Site Requirements



- Maintain the minimum clearance around the printer as shown in the following illustrations.

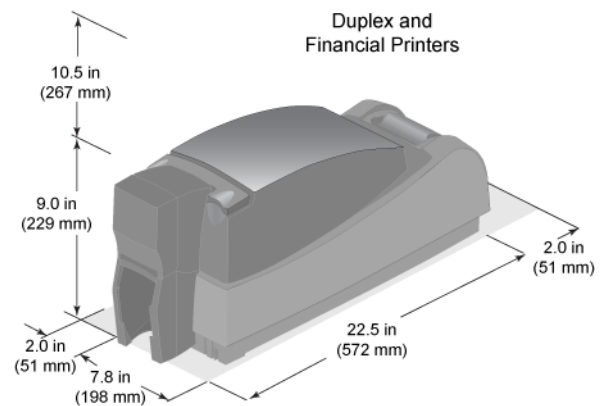
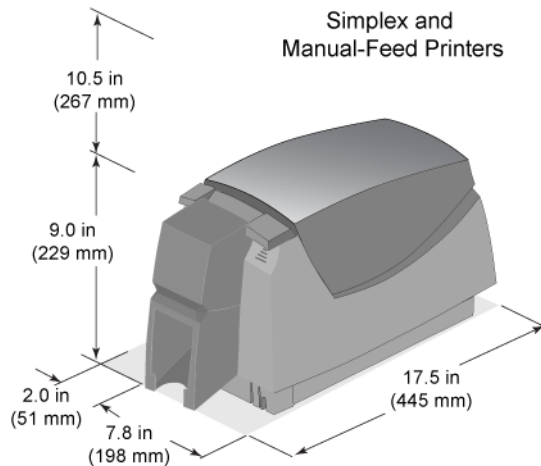

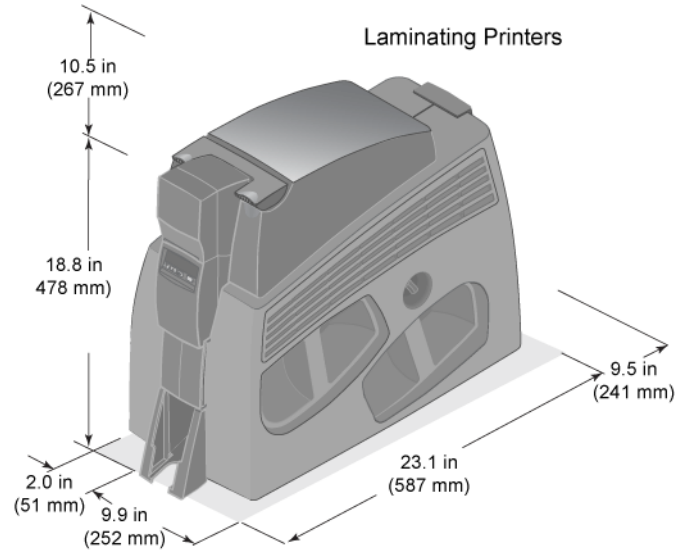

- Place the printer in an environment with temperatures ranging from 60° F to 95° F (15° C to 35° C).
- Use a single phase, 3-wire, grounded receptacle.
- Keep all dust, dirt, food, and liquids away from the printer.
- Keep paper and foreign materials off the printer.
- Place the printer on a sturdy, level surface.
- Place the printer away from direct sunlight.
- Do not place printer near heat ducts, fans, or other air vents.
- Do not use the printer for purposes other than the intended use.
- Prevent debris from entering the printer.
- Place the printer in a clean office environment, protected from any type of construction.

Electrical Requirements

The power supply is rated as follows:

Printer Model	Voltage, AC [#]	Cycle, Hz [#]	Amps
Manual Feed	100-120, 220-240	50-60	3.0
Simplex	100-120, 220-240	50-60	3.0
Duplex	100-120, 220-240	50-60	3.0
Laminating	100-120, 220-240	50-60	3.0

#. Self-adjusting

Choosing Your Installation Method



Your installation method depends on how many users will print to the card printer, the operating system you will use to send card data, and other decisions in your environment.

Will you print from a PC running a Windows operating system?

If yes, continue with "[Windows Installation Choices](#)".

Will you print from a PC running a Linux operating system?

If yes, see "[Open Platform Driver Installation](#)".

Will you print monochrome cards using ASCII data and the Open Card format?

If yes, see "[Open Card Installation](#)".

Windows Installation Choices

Do you have a CD for installation or will you use downloaded files?

The printer ships with a CD in the printer carton. In most cases, install the driver from the CD. In the following situations, install the driver from a downloaded file:

- You do not have access to the CD.
- You are using the Windows 2000 operating system on the PC and the CD does not list Windows 2000 as a supported operating system. You can install the 7.x or 2.x driver. See "[Driver Co-existence on Windows](#)" for details.

See "[Installing from Downloaded Files](#)" to install from downloaded files.

Will you use bidirectional (two-way) communication between the printer and driver?

Bidirectional communication is the method the printer and driver are designed to use. It is required to enable all the printer and driver features. Continue with these questions if you plan to use bidirectional communication.

If you do not plan to use bidirectional communication, see "[Unidirectional Printing](#)" for more information about installation choices and instructions.

Will you connect the printer to the PC using a USB cable?

Using a USB cable between a port on the PC and the USB port on the printer is called local installation. To install the printer using a local USB connection, see "[Local USB Installation Using Bidirectional Communication](#)".

Will you connect the printer and PC to the network, with a network cable connecting the printer's network port to your network?

Using the optional built-in Ethernet port on the printer and a network port is called a direct network connection. To use a direct network connection, see "[Network Installation Using the Built-in Ethernet Port & Bidirectional Communication](#)".

Will you connect the printer to the network using a print server?

Printers with only a USB connection can be used over a network if the printer USB port is connected to a print server and the print server is connected to the network. To use a print server for networked printing, see "[Network Installation Using a Print Server & Bidirectional Communication](#)".

Will you connect the printer to the PC using a wireless connection?

Printers can be wirelessly connected to a PC or to a network, using a wireless print server. To use a wireless connection for the printer, see "[Wireless Network Connection](#)".

Will you install more than one printer on a PC?

Do you want to send cards from one PC to two or more printers? You can install several printers on a PC, using a variety of connection methods.

To read suggestions for successfully using more than one printer from a PC, see "[Installing More than One Printer on a PC](#)".

Will you install one printer on the network, and print to it from several PCs?

You can connect one printer to several PCs on a network. There are no special concerns when sending cards from several PCs.

Do you want to use a printer pool, where the PC distributes the cards to the first available printer?

A printer pool collects all the card printers installed on one PC into a group and sends cards to the next available printer. To set up and use a printer pool, see "[Printer Pooling](#)".

Do you want to install the printer on one PC, and use it from another PC on the network (called printer sharing)?

Printer sharing is a Windows feature that permits using resources on a different PC, when both PCs are installed on the same network. To install and use a shared printer, see "[Shared Printers](#)".

Do you want to use a newer driver in place of the one currently installed?

See "[Updates, Upgrades, and More](#)" for information about updates.

Preparing the Printer

This section describes:

- ["Installing Supplies and Powering on the Printer"](#)
- ["Network Address Settings"](#)

Installing Supplies and Powering on the Printer



This section provides the steps for installing supplies and powering on the printer.

- 1 Unpack the printer.
- 2 Install the continuous cleaning sleeve.

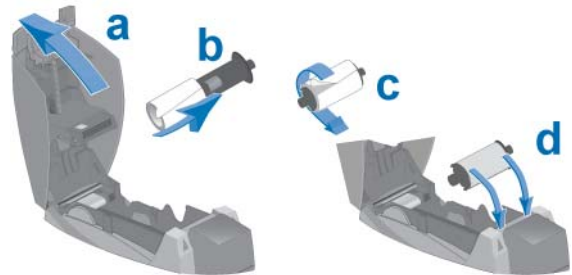

- 3 Load the print ribbon on the cartridge.
 - Place the full spool near the slotted disk.
 - Place the empty spool with the cap near the black gear.



- 4 Install the loaded print ribbon cartridge in the printer.

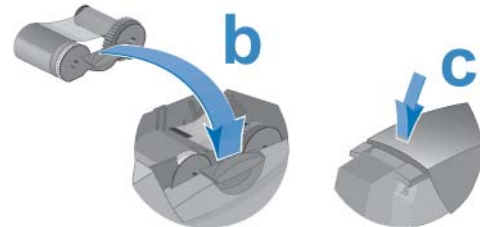

- 5 Install the laminator supply material (if the printer has a laminator).

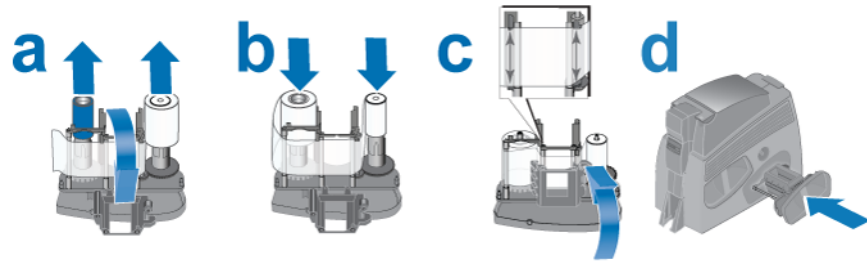

- 6 Load cards in the input hopper (if the printer has a hopper).

Do not connect the printer and PC at this time.

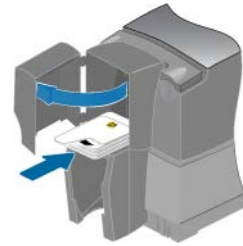

- 7 Power on the PC or host computer. Make sure it is fully operational before connecting the printer.

- 8 For a printer connected using the built-in Ethernet port on the printer, connect the network cable to the printer and to the network now.

For a printer connected using a USB cable or a print server, continue with step 9.

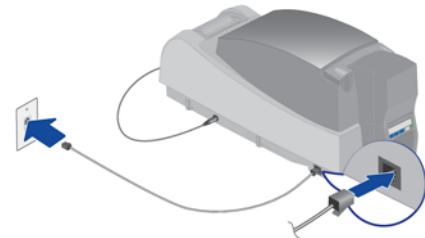

- 9 Power on the printer.

- a Connect the power supply to the printer.
 b Connect the power cable to the power supply.
 c Connect the power cable to a facility power source.



- d For printers with laminators, push the power switch to On.

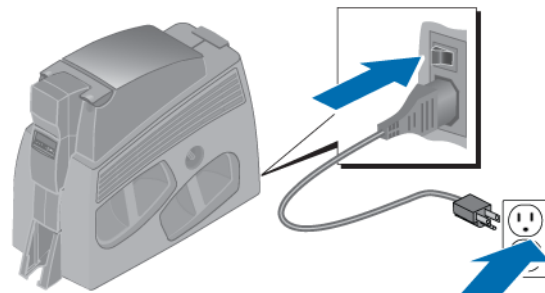

- 10** When the printer powers on, the status light presents a series of patterns. The location of the status light depends on the printer model:

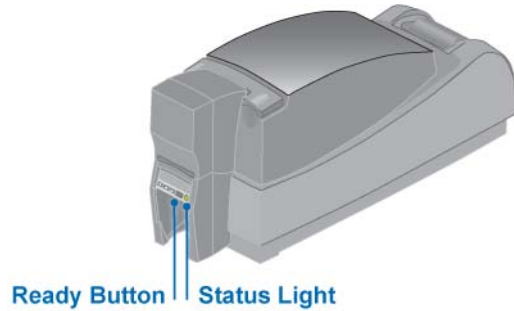
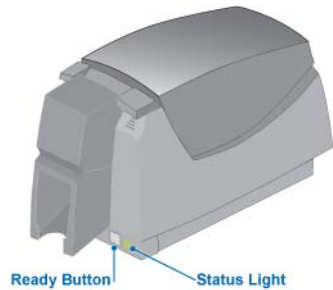

- 11** The status light displays the following:
- Amber when the printer is powered on.
 - A series of colors as it initializes.
 - The printer status light becomes steady green when the printer is ready.



For printers connected using a USB cable between the printer and PC, continue with ["Installation on Windows"](#).

For printers connected over a network, continue with ["Network Address Settings"](#).

Network Address Settings

The Address Mode determines how the network address of the printer is assigned. The choices are DHCP and Static IP. DHCP stands for "Dynamic Host Configuration Protocol" and means that the network assigns the IP Address to the printer. Static IP means that you set the IP Address assigned by your network support personnel. Network support personnel can tell you whether the network uses DHCP or static IP addressing.

Locate the Current Address Mode

- 1** Make sure the printer is connected to the network using an Ethernet cable and is powered on.

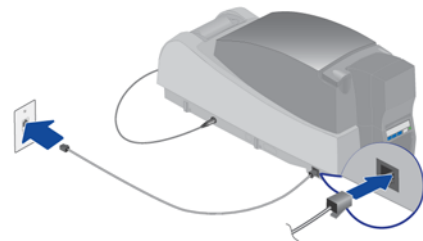

- 2 Begin when the LCD panel shows "Printer Ready" on Line 1 of the display.
- 3 Press the Enter key to enter the menu system.
- 4 Make sure "Status" appears on Line 2 and press the Enter key.

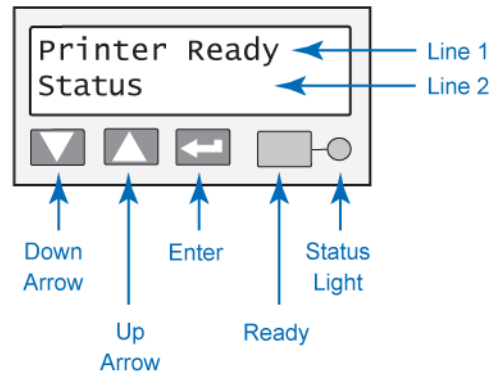

- 5 With "Status Menu" displayed on Line 1, press the Up or Down Arrow key to display "Network" on Line 2.

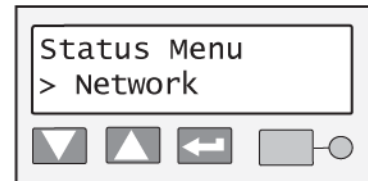

- 6 Press the Enter key. "Address Mode" appears on Line 2.

- 7 Press the Enter key to view the Address Mode. The options are DHCP or Static IP.

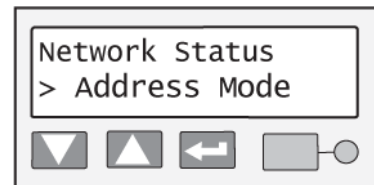

- If the Address Mode is DHCP and that is the choice you will use, continue with ["Retrieve DHCP Values"](#).
- If the Address Mode is Static IP and you plan to use DHCP, see ["Change the Address Mode to DHCP"](#).
- If the Address Mode is DHCP and you will use Static IP, see ["Change the Address Mode to Static IP"](#).
- If the address mode is Static IP and that is the choice you will use, see ["Change Static IP Values"](#).

- 8 Press the Enter key repeatedly to return to the Main Menu. "Exit" is displayed on Line 2. Continue with the section chosen in step 7.

Change the Address Mode to DHCP

- 1 With "Main Menu" displayed on line 1, press the Up or Down Arrow key to display "Configuration."
- 2 Press the Enter key to enter the Configuration menu.



- 3 With "Configuration" displayed on Line 1, press the Up or Down Arrow key to display "DHCP/Static IP" on Line 2.
- 4 Press the Enter key. The current Address Mode value is displayed on Line 2.
- 5 Press the Up or Down Arrow key to display DHCP.
- 6 Press the Enter key.
- 7 Apply/Restart" appears on Line 2. Press the Enter key to restart the printer.
- 8 Continue with "Retrieve DHCP Values".

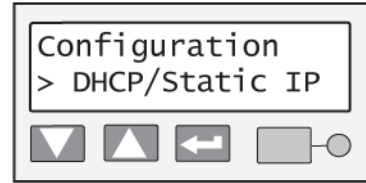

Retrieve DHCP Values

Continue with the following steps after confirming the Address Mode or changing the Address Mode to DHCP.

- 1 Begin when the LCD panel shows "Printer Ready" on Line 1 of the display.
- 2 Enter the Status menu.
 - With "Main Menu" displayed on line 1, press the Up or Down Arrow key to display "Status."
 - Press the Enter key to enter the Status menu.

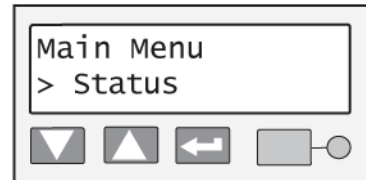

- With "Status Menu" displayed on Line 1, press the Up or Down Arrow key to display "Network" on Line 2.

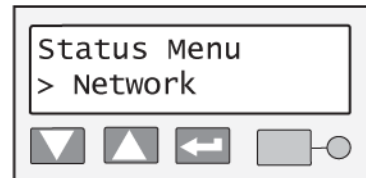

- 3 Press the Enter key. "Address Mode" appears on Line 2.
- 4 Press the Up or Down Arrow key to display IP Address on Line 2.
- 5 Press the Enter key to display the IP Address.

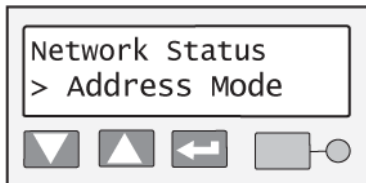

- 6 Write down the IP Address.
- 7 Press the Enter key to return to the Network Status menu. "Subnet Mask" is displayed on Line 2. Press the Enter key to display the Subnet Mask.
- 8 Press the Enter key to return to the Network Status menu. "Gateway Addr" is displayed on Line 2.
- 9 Press the Enter key to display the Gateway Address.
- 10 Press the Enter key to return to the Network Status menu. Press the Up or Down Arrow key to display "Exit" on Line 2.
- 11 Press the Enter key repeatedly to return to the "Printer Ready" display.



Change the Address Mode to Static IP

Continue with the following steps after determining the current Address Mode.

- 1 With "Main Menu" displayed on line 1, press the Up or Down Arrow key to display "Configuration."
- 2 Press the Enter key to enter the Configuration menu.
- 3 With "Configuration" displayed on Line 1, press the Up or Down Arrow key to display "DHCP/Static IP" on Line 2.
- 4 Press the Enter key. The current Address Mode value is displayed on Line 2.
- 5 Press the Up or Down Arrow key to display Static IP.
- 6 Press the Enter key. Continue with ["Change Static IP Values"](#).

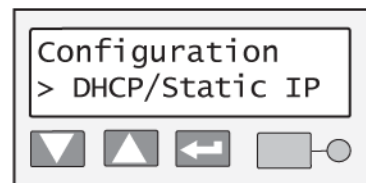

Change Static IP Values

Continue with the follow steps after setting the Address Mode to Static IP or verifying that the Address Mode is Static IP.

- 1 If needed, move to the Configuration menu.
 - With "Main Menu" displayed on line 1, press the Up or Down Arrow key to display "Configuration."
 - Press the Enter key to enter the Configuration menu.

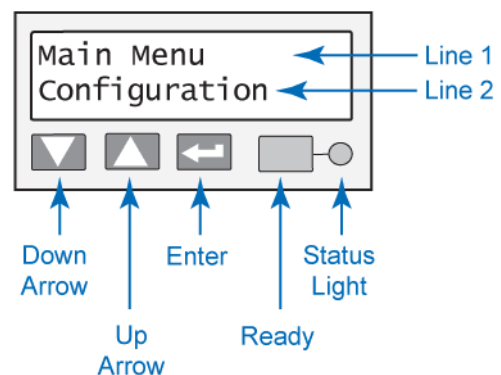

- 2 With "Configuration" displayed on Line 1, press the Up or Down Arrow key to display "IP Address" on Line 2.

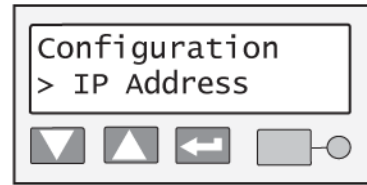

- 3 Press the Enter key to choose IP Address.

- 4 The printer shows the current IP Address and a cursor appears under the first byte of the address. (The address byte shows three digits when it can be changed and the cursor appears under the right-most digit.)

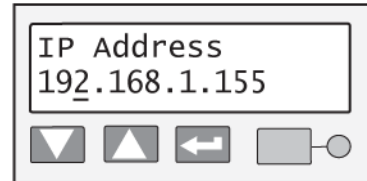

- 5 Press the Up or Down Arrow key to change the numbers of the IP Address.

- 6 When the first byte is correct, press the Enter key to move to the second byte.

- 7 Repeat for the third and fourth byte of the IP Address. After entering the fourth byte of the address and pressing the Enter key, "Subnet Mask" appears on Line 2 of the LCD panel.

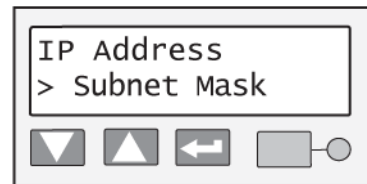

- 8 Press the Enter key. The current Subnet Mask value appears with the cursor under the first byte. Set the Subnet Mask using the same process as the IP Address. After entering the fourth byte and pressing the Enter key, "Gateway Addr" appears.

- 9 Press the Enter key. The current Gateway Address value appears with the cursor under the first byte. Set the Gateway Address using the same process as the IP Address.



- 10 After entering the fourth byte of the Gateway Address and pressing the Enter key, "Apply/Restart" appears.



- 11 Press the Enter key to apply the values and restart the printer.



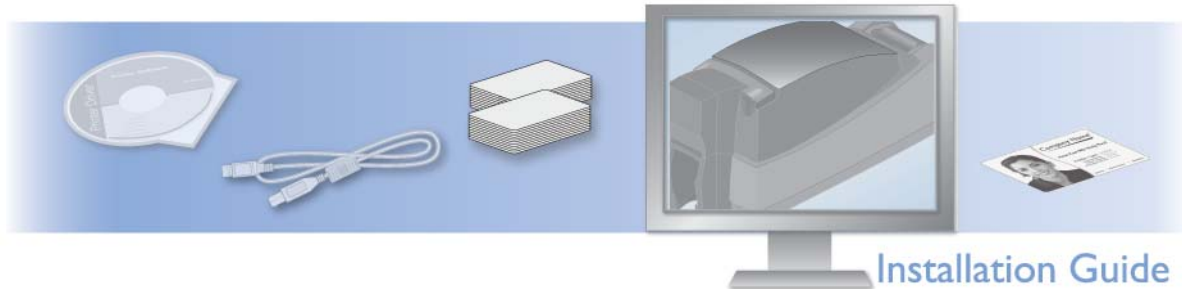

Installation on Windows

This section provides information about installing the printer and driver on a PC running a Windows operating system. See ["Windows Installation Choices"](#) for installation choices.

This section describes how to install the printer on a PC with a Windows® operating system. See the `releasenotes.rtf` file (delivered with the Card Printer Driver) for detailed information about supported Windows operating systems.

Installing on a Windows Operating System

- Bidirectional communication and downloaded files
 - ["Installing from Downloaded Files"](#)
- Bidirectional communication and driver CD
 - ["Local USB Installation Using Bidirectional Communication"](#)
 - ["Network Installation Using the Built-in Ethernet Port & Bidirectional Communication"](#)
 - ["Network Installation Using a Print Server & Bidirectional Communication"](#)
 - ["Installing More than One Printer on a PC"](#)
 - ["Wireless Network Connection"](#)
 - ◁ ["Connection Types"](#)
 - ◁ ["Wireless Network Installation Using an Existing Network"](#)
 - ◁ ["Wireless Network Installation with a Peer \(Ad Hoc\) Network"](#)
- Unidirectional communication
 - ["Unidirectional Printing"](#)
 - ["Removing the Existing Driver"](#)
 - ["Installing the Unidirectional Driver"](#)
- ["Printer Pooling"](#)
- ["Shared Printers"](#)

For troubleshooting, see ["Installation Troubleshooting"](#).

For information on updating an installed driver, see ["Updates, Upgrades, and More"](#).

Installing the Driver with Bidirectional Communication

Installing from Downloaded Files



The printer ships with a CD-ROM in the printer carton. In most cases, install the driver from the CD-ROM. In the following situations, install the driver from a downloaded file:

- You do not have access to the CD-ROM.
- You are using the Windows 2000 operating system on the PC and the CD-ROM does not list Windows 2000 as a supported operating system. See "[Driver Support for Printers](#)" for details.

Before installing the printer, do the following:

- 1 Prepare the printer. See "[Preparing the Printer](#)".
- 2 Obtain the download file, using a method such as the following:
 - Browse to the Downloads area of the Web site (or the Products page for the printer) and choose the driver for your printer and operating system. Click the link. If a License Agreement appears, click "I Agree" or "I Accept." When the File Download dialog appears, click Save. Choose a location on your PC, such as C:\Temp and click Save.
 - Receive the file on a portable storage medium, such as CD-ROM or USB drive, and copy it to your hard drive.
 - Receive the file by email and save it to your hard drive.

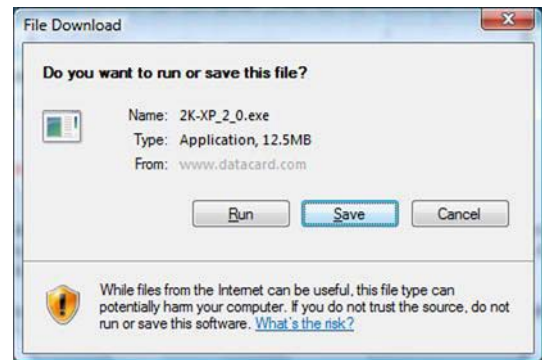

Tips for Success

- The download file will have a name similar to "SP_Series_12_0.exe."
- You can download the file once (saving it to the hard drive) and use it to install the driver on several PCs. The license agreement you accepted during download applies to all installations of the driver.

Installing the Downloaded Driver using a USB Connection



- 1 Prepare the printer for installation. See ["Preparing the Printer"](#) for the steps to follow.
- 2 Log on to the PC as a user with Administrator access.
- 3 Use Windows Explorer to locate the downloaded file.
- 4 Double-click on the downloaded file to start the card printer installation.
- 5 Click "Continue" on the User Account Control dialog box if it appears.
- 6 Click on the "I accept the terms of the license agreement" button and then click Next.

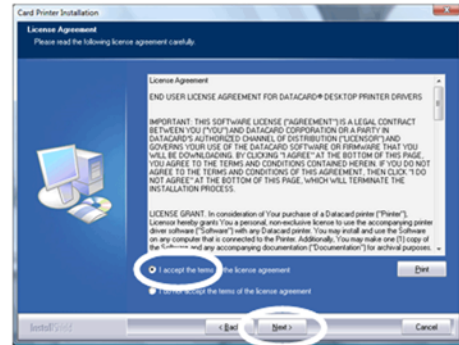

- 7 The installation begins.

- 8 Choose "Local Printer Connection" and click Next.

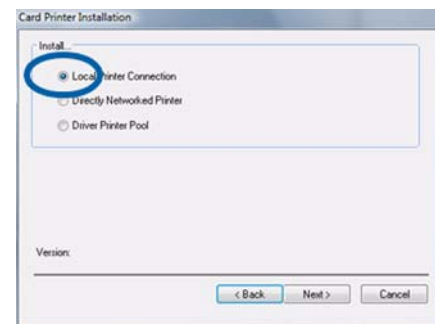

- 9 Verify that you have prepared the printer as instructed on the "Connect . . ." dialog box.

- 10 Connect the USB cable to the printer.

The PC detects the printer.
Wait for installation to complete.

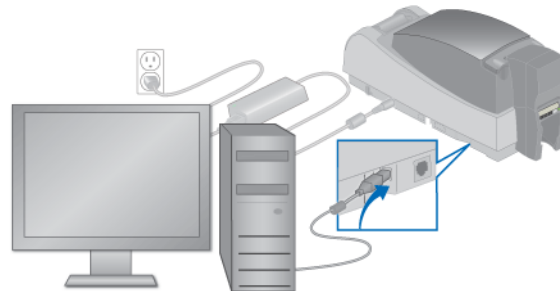

- 11 The PC displays a message.
Click OK.

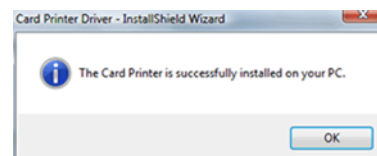

- 12 An icon for the printer appears on the right side of the toolbar. Double-click the icon to open the Printer Toolbox.

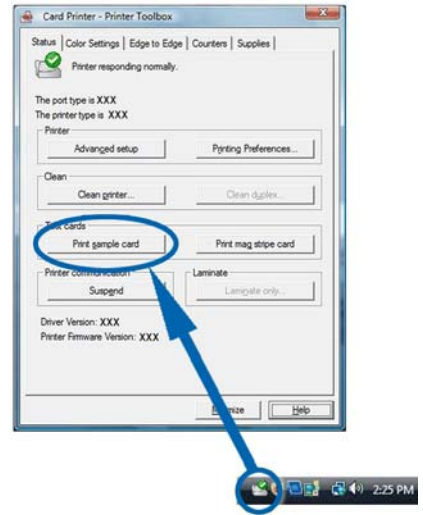

- 13 Click the Print Sample Card button to print a sample card from the driver.
Installation is complete!

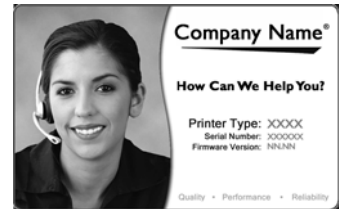

Installing the Downloaded Driver using a Network Connection



- 1 Prepare the printer for installation. See ["Preparing the Printer"](#) for the steps to follow.
- 2 Obtain the IP Address of the printer. See ["Network Address Settings"](#) for details.
- 3 Log on to the PC as a user with Administrator access.
- 4 Use Windows Explorer to locate the downloaded file.
- 5 Double-click on the downloaded file to start the card printer installation.
- 6 Click "Continue" on the User Account Control dialog box if it appears.
- 7 Click on the "I accept the terms of the license agreement" button and then click "Next."

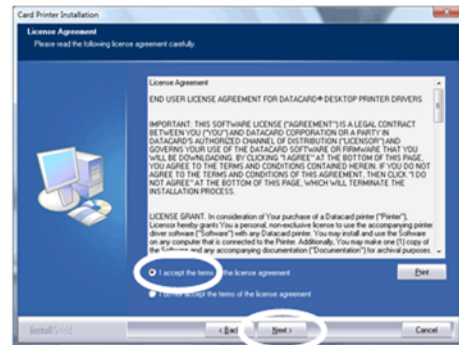

- 8 Choose "Directly Networked Printer" and then click "Next."

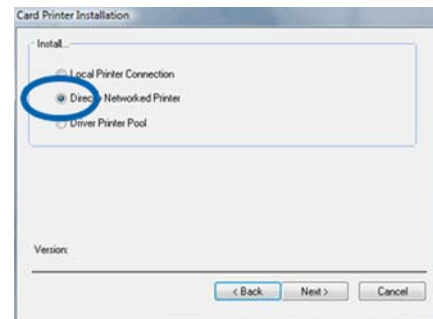

- 9 A prompt appears when the printer and driver have been installed. Click "OK" to close the prompt.
- 10 Restart the PC only if prompted.

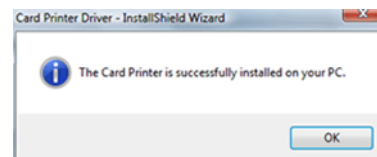

11 The Properties dialog box opens at the end of installation.

12 Choose the Ports tab.

13 Click the name of the printer and then click the Configure Port button.

14 Click on the Enter Network Address box.

15 Enter the IP address in the Enter Network Address dialog box, and then click “Test.”

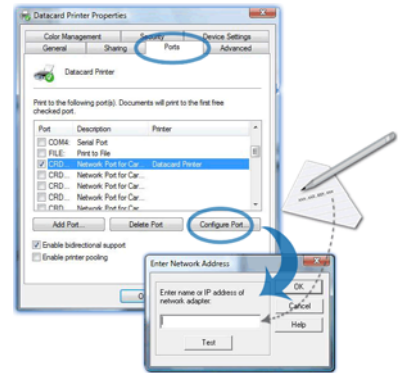

16 Wait for the “Successfully communicated . . . “ response.

— If the “Unable to communicate . . . “ response is displayed, troubleshoot a communication problem. See "[Installation Troubleshooting](#)".

— A “printer detected” message might appear. Allow it to go away on its own.

17 Print a sample card.

a Choose Start > All Programs > Card Printer > Printer Name to open the Printer Toolbox.

If communication between the printer and the driver is suspended, click the “Resume” button.

b Click the Print Sample Card button. The driver prepares the sample card and sends it to the printer.



When the sample card prints successfully, installation is complete.

Installation with the Driver CD

The remaining instructions in this chapter use the Card Printer Driver CD for installation. For best results, use the driver CD when installing the printer.

Local USB Installation Using Bidirectional Communication



- 1 Log on to the PC as a user with Administrator access.
- 2 Click "Continue" on the User Account Control dialog box if it appears.
- 3 Insert the driver CD in the PC's drive. The driver install window opens.
- 4 Click 'Install the Printer'.
- 5 Click "Continue" on the User Account Control dialog box if it appears.



The Card Printer Installation dialog box appears.

- 6 Click the "I accept the terms of the license agreement" button and then click "Next."

The installation begins.

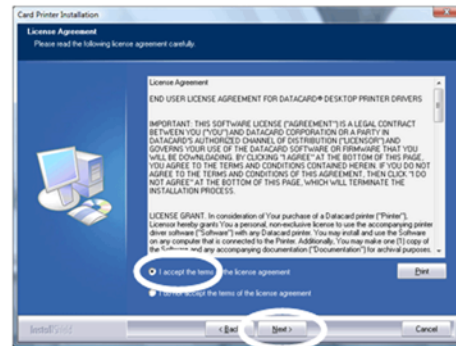

- 7 Select "Local Printer Connection" and click "Next."
- 8 Verify that you have prepared the printer as instructed on the "Connect . . ." dialog box.

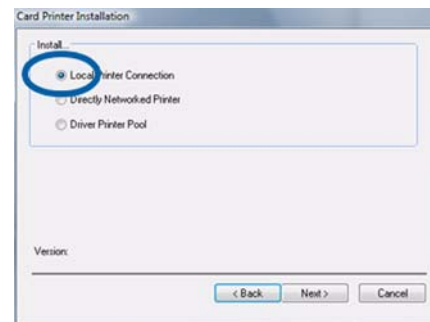

- 9 Connect the USB cable to the printer.
- The PC detects the printer. Wait for installation to complete.

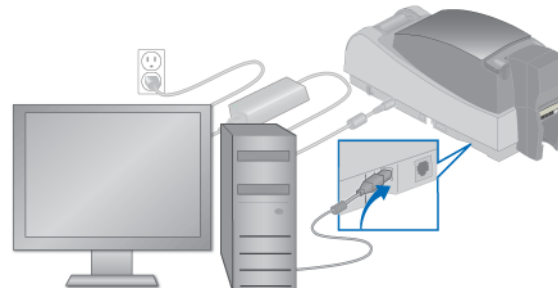

- 10 The PC displays a message. Click OK.

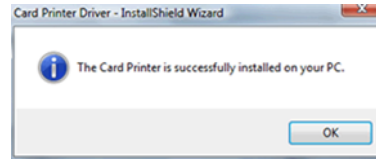

- 11 An icon for the printer appears on the right side of the toolbar. Double-click the icon to open the Printer Toolbox.
- 12 Click the "Print Sample Card" button to print a sample card from the driver.

Printer installation is complete when the sample card prints successfully.

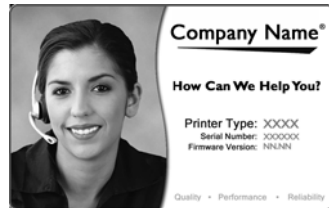
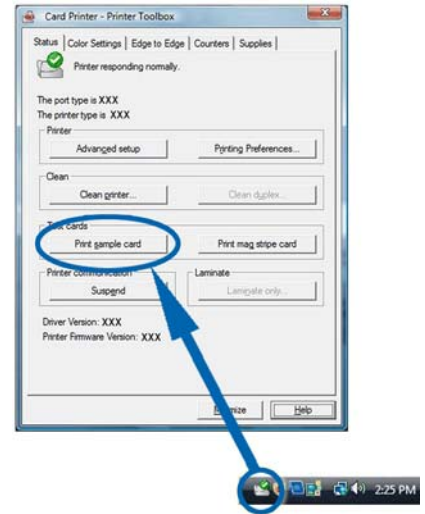

Network Installation Using the Built-in Ethernet Port & Bidirectional Communication



- 1 Prepare the printer for installation. See "[Preparing the Printer](#)" for the steps to follow.
- 2 Obtain the IP Address of the printer. See "[Network Address Settings](#)" for details.
- 3 Log on to the PC as a user with Administrator access.
- 4 Insert the driver CD in the PC's drive. The driver install window opens.



- 5 Click 'Install the Printer.'
- 6 Click "Continue" on the User Account Control dialog box if it appears.

- 7 The Card Printer Installation dialog box appears.
- 8 Click the "I accept the terms of the license agreement" button and then click "Next."

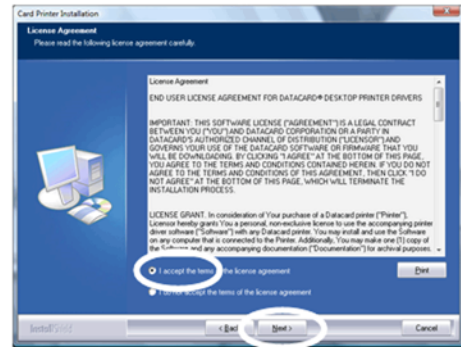

- 9 The installation begins.
- 10 On the "Install . . ." page, choose "Directly Networked Printer" and click "Next."

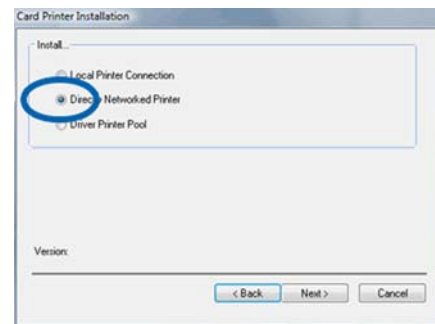

- 11 Wait for the installation to complete and the PC to display a message. Click OK.

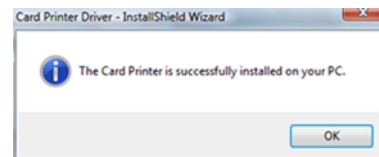

- 12 When the installation is finished, the Properties dialog box opens.
- 13 Choose the Ports tab.
- 14 Click the name of the printer and then click the Configure Port button.
- 15 Click on the Enter Network Address box.
- 16 Enter the IP address in the Enter Network Address dialog box, and then click "Test."
- 17 Wait for the "Successfully communicated . . ." response. Click OK to save the address and close the dialog box.

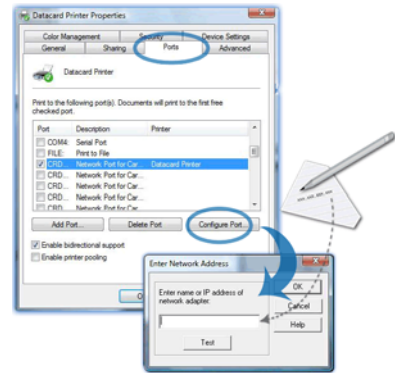

If the "Unable to communicate . . ." response is displayed, troubleshoot a communication problem. See "[Installation Troubleshooting](#)".

- 18 Click OK or Close to close the Properties dialog box.
- 19 A "printer detected" message appears. Allow it to go away on its own.
- 20 Print a sample card.

- a Choose Start > All Programs > Card Printer > Printer Name to open the Printer Toolbox. If communication between the printer and the driver is suspended, click the "Resume" button.



- b Click the Print Sample Card button. The driver prepares the sample card and send it to the printer. When the sample card prints successfully, installation is complete.

Network Installation Using a Print Server & Bidirectional Communication



- 1 Load supplies and then power on the printer. See "[Preparing the Printer](#)".
- 2 Connect the printer to the print server using a USB cable.
- 3 Connect the print server to the network using an Ethernet cable.
- 4 Set up the print server on the network. See the information with the print server for instructions.
- 5 Obtain the print server IP address (or network name) and record it.
- 6 Log on to the PC as a user with Administrator access.
- 7 Insert the driver CD in the PC's drive. The driver install window opens.
- 8 Click 'Install the Printer'
- 9 Click "Continue" on the User Account Control dialog box if it appears.
- 10 The Card Printer Installation dialog box appears.
- 11 Click the "I accept the terms of the license agreement" button and then click "Next."

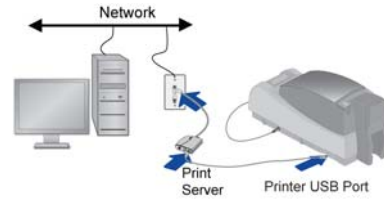

The installation begins.



- 12 On the “Install . . .” page, choose “Directly Networked Printer” and click “Next.”

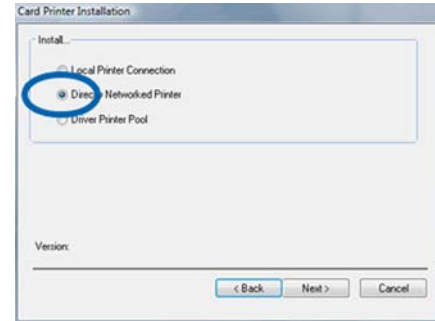

- 13 Wait for the installation to complete and the PC to display a message. Click OK.

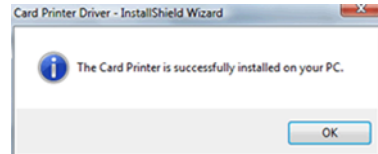

- 14 When the installation is finished, the Properties dialog box opens.

- 15 Choose the Ports tab.

- 16 Click the name of the printer and then click the Configure Port button.

- 17 Click on the Enter Network Address box.

- 18 Enter the IP address (or network name) in the Enter Network Address dialog box, and then click “Test.”

- 19 Wait for the “Successfully communicated . . .” response. Click OK to save the address and close the dialog box.

If the “Unable to communicate . . .” response is displayed, troubleshoot a communication problem. See ["Installation Troubleshooting"](#).

- 20 Click OK or Close to close the Properties dialog box.

- 21 A “printer detected” message appears. Allow it to go away on its own.

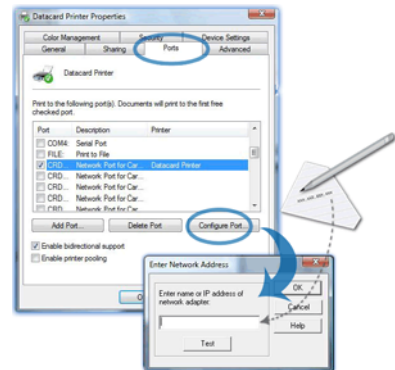

22 Print a sample card.

- a** Choose Start > All Programs > Card Printer > Printer Name to open the Printer Toolbox.
If communication between the printer and the driver is suspended, click the “Resume” button.
- b** Click the Print Sample Card button. The driver prepares the sample card and send it to the printer. When the sample card prints successfully, installation is complete.



Installing More than One Printer on a PC



You have several choices for having more than one printer connected to a PC or for having more than one PC connected to a printer. Choices include:

- Installing two or more printers on one PC using USB ports. See "[Installing more than one printer using a USB connection](#)" for details.
- Installing more than one networked printer on a PC using the built-in Ethernet port on the printer. Each installation follows the same procedure. See "[Network Installation Using the Built-in Ethernet Port & Bidirectional Communication](#)".
- Installing more than one networked printer on a PC using a print server. Each installation follows the same procedure. See "[Network Installation Using a Print Server & Bidirectional Communication](#)".
- Installing multiple printers on a PC using a combination of connection methods. For example, one or more printers can be connected to the PC using a USB connection and others can be connected through a network (using direct networking or Windows printer sharing).
- Using more than one printer installed to a PC as a printer pool, when the PC is running a Windows operating system. The operating system manages sending jobs to the printers so the next available printer receives the print job. See "[Printer Pooling](#)" for details.
- Installing a printer on a client PC when the printer is connected to a host PC and both PCs are connected to a network (using Windows printer sharing). See "[Shared Printers](#)" for more information.

Installing more than one printer using a USB connection

Tips for success

- Connect and install one printer at a time. The PC cannot run two or more installation programs at the same time.
 - The USB protocol allows devices to be connected to the PC through another USB device (daisy-chained). USB also uses hubs to which multiple USB devices (including other hubs) can be connected (cascaded).
 - Up to five hubs can be used between the printer and the PC. Card printers do not have ports to support daisy chaining. If you need to connect two card printers to a PC with one USB port, obtain a USB hub to which both printers can be connected.
 - Every other hub in a daisy chain must be powered.
 - The printer must be powered on for the PC to detect it. It must remain powered on during installation.
- 1 Load supplies and then power on the printer. See "[Preparing the Printer](#)" for the steps to follow.
 - 2 Begin with the PC powered on and running.
 - 3 Log on to the PC as a user with Administrator access.
 - 4 Exit the Printer Toolbox (if it is running) for each printer already installed on the PC. You cannot exit the Printer Toolbox until all jobs to the printer are complete and any messages are cleared.

- a Locate the icon for the Printer Toolbox in the system tray, usually the lower right corner of the desktop.
- b Right-click the icon to display the popup menu.
- c Choose Exit.

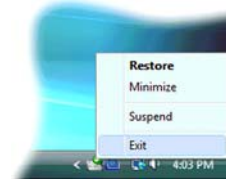

- 5 Prepare the printer and power it on. See "[Preparing the Printer](#)".
- 6 Attach the flat end of the USB cable to the USB port on the PC or on a device connected to the PC.
- 7 Attach the square end of the USB cable to the printer.

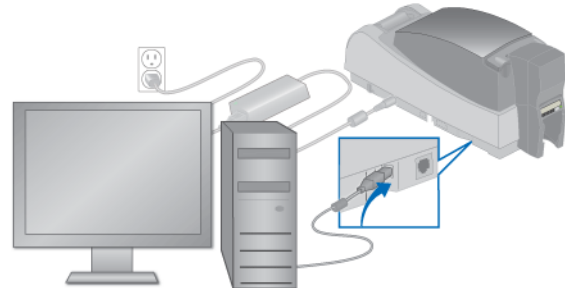

- 8 The operating system detects the new device. It might display a popup during installation.



- If the operating system does not display a popup within a few minutes, check the Printers window to see if the icon for the new printer is displayed. At times, the software installs without displaying the popup. If the Wizard does not appear and the icon is not present, see "[Installation Troubleshooting](#)" for more information.

- 9 The operating system usually displays a message when the printer has been successfully installed.
- 10 The operating system usually uses the existing driver files to install the driver for this printer. Insert the driver CD only if you are prompted for it.

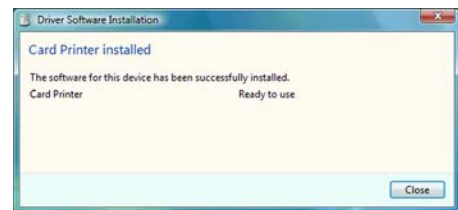

Using more than one printer on a PC



When using more than one printer on a PC, keep the following in mind:

- Select the printer to use in the ID software or other application. Card jobs will be sent to the selected printer even if more than one card printer is attached to the PC.
- When messages are displayed, the title bar of the message box displays the name of the printer causing the message. Keep track of which printer has which name.
- Each printer has its own icon in the Printers window, and each printer has separate Properties and Printer Preferences dialog boxes. Settings are not shared among printers.
- The PC has a Printer Toolbox for each printer installed. Open each Printer Toolbox by choosing Start > Programs > Card Printer > Printer name. When the Printer Toolbox is open, the printer name appears in the title bar.

Wireless Network Connection

To install the printer using a wireless network connection, you must have:

- Equipment, including cables, for the wireless connection method you have chosen.
- Knowledge of wireless communication.

Connection Types



For wireless printing, the card printer is connected to a bidirectional wireless print server using a USB cable. The wireless print server receives data from another wireless device. The sending device can be part of a network or attached to a PC.

Existing Network

A networked connection includes the typical components of an organization's existing network, including servers, cables, routers, and PCs. The network must be enabled for wireless communication through one or more access points.

PCs on the network must install the driver for the card printer to send cards to the printer. PCs send data over the network, which transmits the data through an access point to the wireless print server and printer. The printer returns status information to the PC using the same path.

The printer location is limited by the range and availability of access points. This method can also be called infrastructure mode. See ["Wireless Network Installation Using an Existing Network"](#) for the steps to follow.

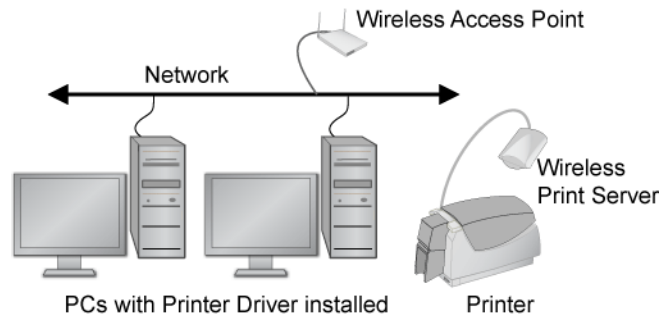

Peer-to-Peer

A peer-to-peer network is made up of PCs equipped with wireless adapters and the printer with wireless print server. The PCs have the driver for the card printer installed, and transmit print data from the PCs wireless adapter to the wireless print server. The printer returns status information to the PC using the same path.

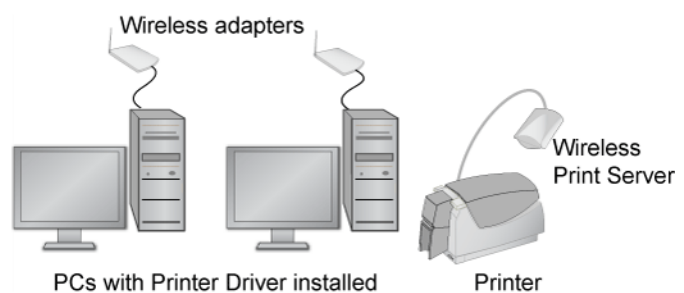

A peer-to-peer network can also be called a local network or an ad hoc network. See "[Wireless Network Installation with a Peer \(Ad Hoc\) Network](#)" for the steps to follow.

Wireless Network Installation Using an Existing Network



- Make sure you have the following:
 - A bidirectional wireless print server with cables and documentation.
 - A wireless network with one or more access points available to the printer.
 - A PC with a wireless adapter that uses the same wireless protocol (such as 802.11g) as the print server.
 - For a wired or wireless infrastructure (existing network) connection, the PC must be connected to and working on an Ethernet network.

A bidirectional wireless network connection was tested using the HP® Jetdirect® 380x, revision A, bidirectional wireless print server. The print server was connected to the printer using a USB cable.
- Network support personnel can tell you whether the network uses DHCP or static IP addressing.
 - If it uses static IP addressing, obtain the IP address, subnet mask, and gateway address from network support personnel. You will assign these values to the print server.
 - If the network uses DHCP, you will obtain these values from the print server configuration utility and use them when setting up the PCs that send jobs to the printer.
- Most networks use encryption to protect data transmitted using the access points. Network support personnel can provide the information you need to set up encryption on the wireless print server.

Install and Set Up the Wireless Print Server

- 1 Log on to the PC as a user with Administrator access (Vista) or with Administrator permissions (XP).
- 2 Prepare the printer for installation. See "[Preparing the Printer](#)" for the steps to follow.
- 3 Install the wireless network adapter, including the adapter's driver files, to a nearby PC. Follow the instructions provided with the adapter to install it.
- 4 Change settings in the utility for the wireless network adapter (if needed) to match the default settings for the wireless print server. Find the settings in the print server information.

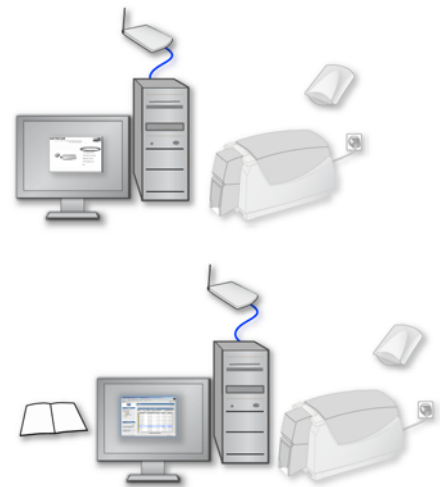

- 5 Power on the wireless print server. The power light on the print server will be on.
 - For best results, try to set up the print server without connecting the printer. If the wireless network adapter utility does not find the print server, you might need to connect the print server to the printer.

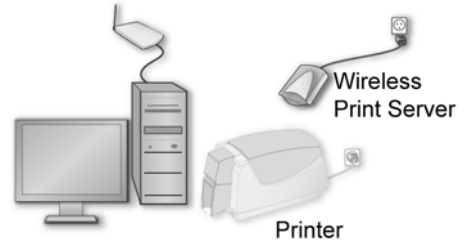

- 6 Insert the wireless print server CD in the PC with the wireless network adapter. Follow the instructions provided with the print server to set it up.

Record the values you use so you can repeat the setup for other devices and to finish configuring the connection to the printer.

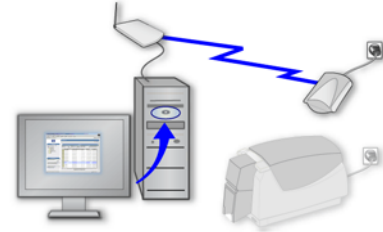

- 7 Network support personnel can provide the network settings to use. Set up the print server so it communicates with the network through the access point.

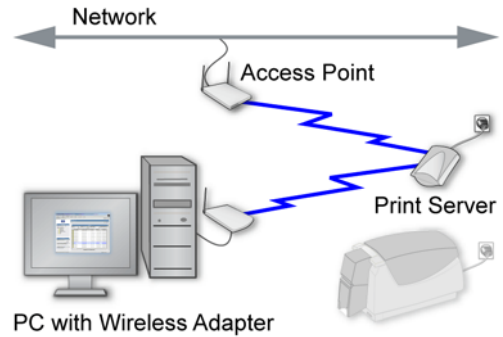

- 8 Connect the print server and printer using a USB data cable (if it is not already connected).

You can remove the wireless adapter from the PC. Future communication will occur over the network.

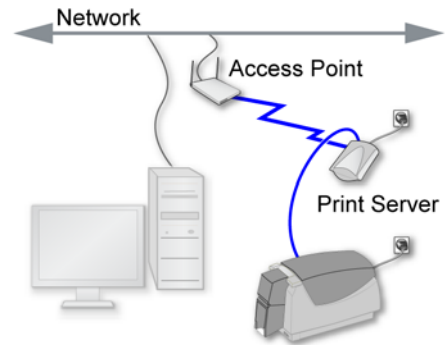

Install and Set Up the Driver

On each PC that will send jobs to the printer, install the driver for the card printer. Follow the steps in "[Network Installation Using a Print Server & Bidirectional Communication](#)" on page 27 with the following changes:

- Make sure that each printer has a unique name (such as Card Printer 1 or Card Printer 2) on the PC.
- Make sure you are logged in as the Administrator. (Users and Power Users cannot complete this task successfully.)
- For step 16, enter the print server name or IP address of the print server. If your network uses DHCP, use the print server name (not the IP address, which the network can change).
- The Print Sample Card button in the Printer Toolbox is enabled when the printer and driver communicate normally. If the Print Sample Card button is gray, check the following:
 - The printer is suspended. Click the Resume button.
 - The printer is busy processing a print job sent by another user on the network.
 - The printer is paused. Check that the Status Light on the front of the printer is steady green.



See "[Printing Cards Using Bidirectional Communication](#)" to print cards.

Wireless Network Installation with a Peer (Ad Hoc) Network



- Make sure you have the following:
 - A bidirectional wireless print server with cables and documentation.
 - For each PC that will print, a wireless adapter that uses the same wireless protocol (such as 802.11g) as the print server.
 - A wireless network connection was tested using the HP® Jetdirect® 380x, revision A, bidirectional wireless print server. The print server was connected to the printer by a USB cable.
- Obtain information about setting up encryption if the peer-to-peer network will use it.

Install and Set Up the Wireless Print Server

1 Prepare the printer for installation. See ["Preparing the Printer"](#) for the steps to follow.

2 Install the wireless network adapter, including the driver files, to a nearby PC. Follow the instructions provided with the adapter to install it.

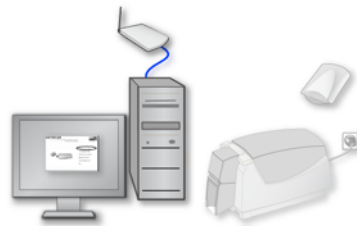

3 Change settings in the utility for the wireless network adapter (if needed) to match the default settings for the wireless print server. Find the settings in the print server information.



4 Power on the wireless print server. Do not connect the print server to the printer at this time (this sequence might be different from the one the print server recommends). The power light on the print server will be on.

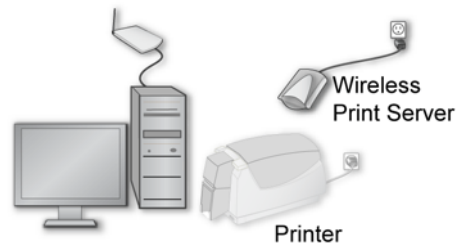

5 Insert the wireless print server CD in the PC with the wireless network adapter. Follow the instructions provided with the print server to set it up.

Record the values you use so you can repeat the setup for other PCs.

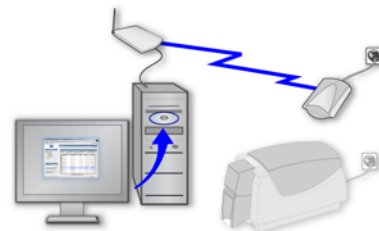

- 6 On each PC that will print, set the wireless adapter to communicate with the print server.

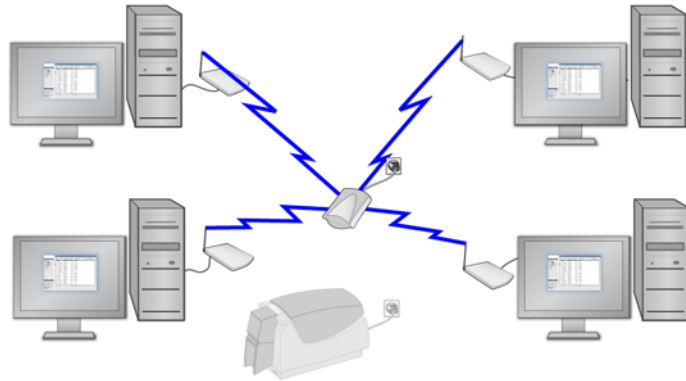

- 7 Connect the print server and printer using a USB data cable.

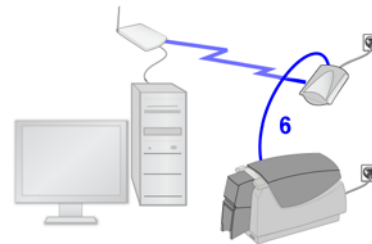

Install and Set Up the Driver

On each PC that will send jobs to the printer, install the driver for the card printer. Follow the steps in "[Network Installation Using a Print Server & Bidirectional Communication](#)" on page 27 with the following changes:

- Make sure that each printer has a unique name (such as Card Printer 1 or Card Printer 2) on the PC.
- Make sure you are logged in as the Administrator. (Users and Power Users cannot complete this task successfully.)
- For step 16, enter the print server name or IP address of the print server. If your network uses DHCP, use the print server name (not the IP address, which the network can change).
- The Print Sample Card button in the Printer Toolbox is enabled when the printer and driver communicate normally. If the Print Sample Card button is gray, check the following:
 - The printer is suspended. Click the Resume button.
 - The printer is busy processing a print job sent by another user on the network.
 - The printer is paused. Check that the Status Light on the front of the printer is steady green.

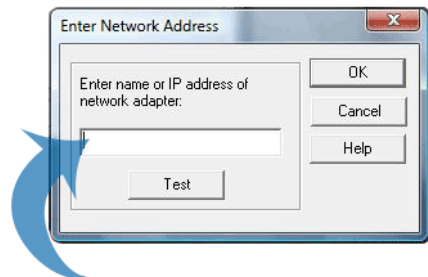

See "[Printing Cards Using Bidirectional Communication](#)" to print cards.

Printing Cards Using Bidirectional Communication



In the Windows environment, the typical printer installation uses bidirectional communication. See "[Installation on Windows](#)" for details about installing the printer. When bidirectional communication between the printer and driver are active, the following occurs:

- The driver “reads” the type of printer connected and its options (such as duplex or magnetic stripe), and then enables the settings (in the Printer Toolbox and Printing Preferences) for the features available.
- The driver “reads” the type of ribbon in the printer (or, for manual-feed printers, whether it is set for rewritable cards) and enables settings that correspond to the capabilities of the print media.
- The driver monitors the printer, and reads any errors the printer issues. The driver displays a message when it reads an error. You must correct the problem with the printer to continue.
- When you choose some settings, such as edge-to-edge printing, the driver sends settings to the printer.
- When you choose some buttons such as “Clean Printer” the driver sends a command to the printer and the printer implements the process.
- When the user sends a card to print, the driver renders the data so it can be used by the printer. The driver also polls the printer to determine when it is ready to print, and then sends the card data to the printer. The printer receives the card data, and prints the card. The printer issues status and other information. The driver can read whether the printer is busy, is ready to print cards, or has an error. The driver reacts to the printer information as already described.
- When the driver communicates with a network printer, it waits until the printer is “available” before sending card data. The time between sending a card and the start of printing is not predictable when printer over a network.

The Printer Toolbox and the Printing Preferences dialog box provide the user with information about the printer features and status. See *InfoCentral > Features > Printer Toolbox* to learn about the Printer Toolbox. See *InfoCentral > Advanced > Printing Preferences* to learn about using Printing Preferences. See *InfoCentral > Features* to learn about features the printer might have and how to choose settings for the features.

Unidirectional Printing



"Unidirectional" means that the driver sends data to the printer, but does not receive any data back from the printer—the communication is in one direction only. A unidirectional driver can be installed on PCs running a Windows operating system. A unidirectional driver is included on the driver CD-ROM or in the driver download files.

To use the printer with Windows Terminal Services, and in environments such as Citrix® Presentation Server that require Terminal Services, you must install the unidirectional driver.

Many features of the driver depend on bidirectional communication, including when to send data to the printer. See ["Printing Cards in the Windows Terminal Services Environment"](#) for information about how to operate the printer in a unidirectional environment. Consider sharing this information with operators.

Your success might depend on the amount of data per card and number of cards sent. For best results, use simple card layouts and send individual cards, or send batches with a small number of cards to print at one time.

Installing the Unidirectional Driver

This section includes:

- ["Removing the Existing Driver"](#)
- ["Network Unidirectional Installation for Windows XP & Server 2003"](#)
- ["Network Unidirectional Installation for Windows 7, Windows Vista & Windows Server 2008"](#)
- ["Network Unidirectional Installation for Windows XP & Server 2003"](#)
- ["Local USB Unidirectional Installation for Windows 7, Windows Vista & Windows Server 2008"](#)

Do not rename the unidirectional printer

The printer name, (*brand*) UniDir, must be used for the unidirectional driver. Do not change this part of the printer name. If you have more than one unidirectional driver installed, you can change the (copy n) at the end of the printer name if needed. For example, one PC could have two printers, with names Datacard UniDir and Datacard UniDir Net, that use the unidirectional driver. The brand of your printer might be different.

Removing the Existing Driver



Before you install the unidirectional driver with Terminal Services, remove any existing drivers for the card printer.

To remove existing Card Printer Drivers:

- 1 Disconnect the card printer from the PC. If more than one card printer is installed on the PC, disconnect all of them.
- 2 Log on to the PC as a user with Administrator access.
- 3 Open the Printers window:
 - For Windows XP, choose Start > Settings > Printers and Faxes.

- For Windows Server 2003 and some XP installations, choose Start > Printers and Faxes.
- For Windows 7, Windows Vista and Windows Server 2008, choose Start > Control Panel > Hardware and Sound > Printers.

- 4 Click once on the icon for the printer to select it.
- 5 Press the Delete key.
- 6 Reply Yes or OK to prompts asking if you want to delete the driver.
- 7 Repeat steps 4, 5, and 6 for each card printer installed.

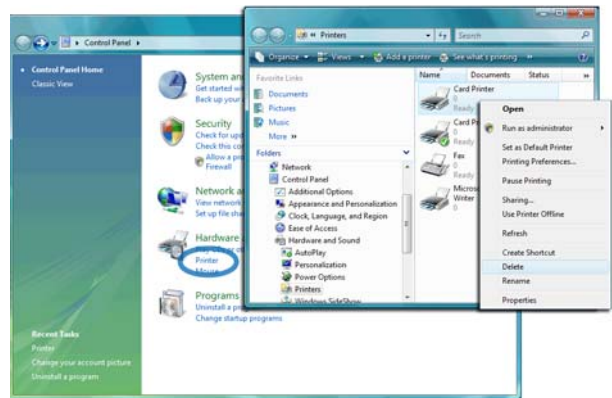

- 8 If you delete the default printer, Windows displays a message. Click Close or OK to close the message.
- 9 Choose Start > Programs > Card Printers > Uninstall Driver Software.
- 10 Click Continue on the User Account Control box if it appears.
- 11 Click Yes on the Uninstall driver software dialog box.
- 12 Click OK on the message box that displays "Driver software was removed."
- 13 Restart Windows to complete removal of locked files.



You are ready to install a printer for unidirectional operation.

Network Unidirectional Installation for Windows XP & Server 2003



Before you begin:

- This installation is possible only on PCs running Windows XP or Windows Server 2003.
- Use the files on the driver CD-ROM. The driver CD-ROM contains files to install the Network Port Monitor, which is required to install the unidirectional driver on a network.
- Obtain information from your network support personnel.

— You need:

- ◁ Address Mode, either DHCP or Static IP
- ◁ IP Address for Static IP address mode
- ◁ Network name if using a print server

— You might also need:

- ◁ Gateway Address
- ◁ Subnet Mask

— Your network personnel might ask you for the network name (if using a print server), the printer's current IP address if using DHCP, or the MAC Address of the device.



- 1 Load supplies and then power on the printer. See "[Preparing the Printer](#)" for the steps to follow.
- 2 Power on the print server, if used. Record the default print server name, usually provided on the device label, or set the print server to use the IP address from network support personnel. See the information with the print server for instructions.
- 3 Obtain or set the IP Address of the printer if you are not using a print server. See "[Network Address Settings](#)" for details.
- 4 Log on to the PC as a user with Administrator permissions.
- 5 Insert the driver CD in the PC's drive. When the Card Printer Installation window opens, click "Exit" to close the window.
- 6 Browse the driver CD to locate the Support\Net Port Mon Install folder, and then double-click the setup.exe file in that folder to start installation of ports named CRDNETx (where x is a number).

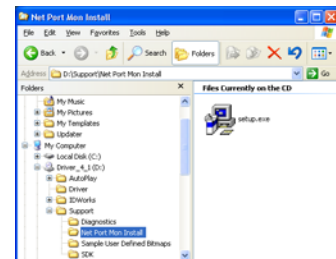

- 7 Follow the prompts to complete port installation.
- 8 Do one of the following to open the Printers window:
 - For Windows XP, choose Start > Settings > Printers and Faxes.
 - For Windows Server 2003 and some XP installations, choose Start > Printers and Faxes.



- 9 Double-click "Add Printer" to start the installation.
- 10 Choose "Local Printer." Make sure the choice to automatically detect and install the printer is NOT checked, and click "Next."
- 11 In the Use the Following Port list, choose "CRDNETx" (where x is a number) and then click "Next."
- 12 On the page that lists manufacturers and printers, click "Have Disk" and browse to the location of the driver files (such as the driver CD).
- 13 Choose the CardPrinter.inf file and click "Open" and "OK" as needed to continue.



- 14 From the list of available drivers, choose the unidirectional driver. The name will include Unidir (or a similar word).
- 15 Click "Next" and follow the prompts to continue.
- 16 If prompted to keep the existing driver, choose "Keep Existing Driver."
- 17 For some drivers, the Windows Logo testing dialog box appears. Click "Continue Anyway" to install the driver.
- 18 Follow the prompts to continue.

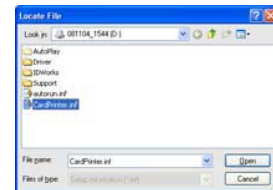

- 19 Click "Finish" to complete driver installation.
- 20 Power the printer off and then on.
- 21 Restart Windows.
- 22 Do one of the following to open the Printers window:
 - For Windows XP, choose Start > Settings > Printers and Faxes.
 - For Windows Server 2003 and some XP installations, choose Start > Printers and Faxes.

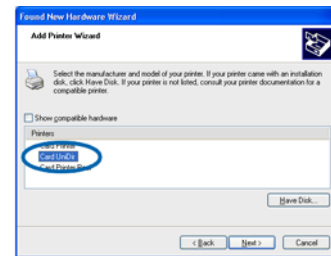

- 23 Click on the icon for the installed printer.
- 24 Choose File > Printing Preferences to open the Printing Preferences dialog box.
- 25 Click the "Advanced" button to open the Advanced page.
- 26 Change the Printer Type setting to match the model shown on the front of the printer. Click OK on the Advanced page and the Printing Preferences page to close them.
- 27 Open the Advanced page of Printing Preferences again. (The Printer Type setting might change the choices available.)
- 28 The default Print Ribbon Type is YMCKT. If a different type of ribbon is installed in the printer, change the Ribbon Type.
- 29 Change other settings, such as Duplex Method or Mag stripe settings, if needed to match the printer. Close the Printing Preferences dialog box.



30 With the printer icon highlighted, choose File > Properties to open the Properties dialog box.

31 Choose the Ports tab, click once on the port for the printer, and then click the Configure Port button.

32 Click on the Enter Network Address box.

33 Enter the name or IP address of the printer or print server.

For best results with a print server and DHCP, use the print server name (not the IP address, which the network can change).

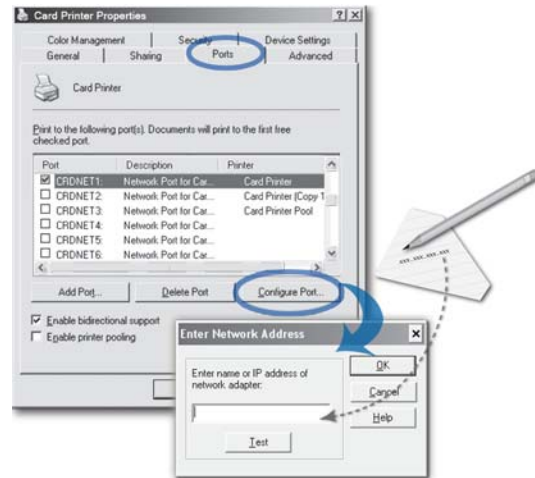

34 Click the Test button. Wait to see the "Successfully communicate . . ." message and then click OK to close the message. If the PC does not communicate with the printer, see ["Installation Troubleshooting"](#).

35 Click OK to close the Enter Network Address dialog box.

36 On the General tab of the Properties dialog box, click "Print Test Page" to print the Windows test page.

37 Verify that the Windows test page prints. The image on the card is likely to be cropped; this is expected.

38 Click OK when the card prints, and then close the Properties dialog box.

If you have not restarted the PC and the printer, the Windows test page might not print or might cause an error at the printer. Restart the printer: Do not follow Windows troubleshooting.

To continue, see ["Set up the Unidirectional Printer"](#).



Network Unidirectional Installation for Windows 7, Windows Vista & Windows Server 2008



Before you begin:

- This installation is possible only on PCs running Windows 7, Windows Vista or Server 2008 operating systems.
- Use the files on the driver CD-ROM. The driver CD-ROM contains files to install the Network Port Monitor, which is required to install the unidirectional driver on a network.
- Obtain information from your network support personnel.
 - You need:
 - ◁ Address Mode, either DHCP or Static IP
 - ◁ IP Address for Static IP address mode
 - ◁ Network name if using a print server
 - You might also need:
 - ◁ Gateway Address
 - ◁ Subnet Mask
 - Your network personnel might ask you for the network name (if using a print server), the printer current IP address if using DHCP, or the MAC Address of the device.



- 1 Load supplies and then power on the printer. See ["Preparing the Printer"](#) for the steps to follow.
- 2 Power on the print server, if used. Record the default print server name, usually provided on the device label, or set the print server to use the IP address from network support personnel. See the information with the print server for instructions.
- 3 Obtain or set the IP Address of the printer if you are not using a print server. See ["Network Address Settings"](#) for details.
- 4 Log on to the PC as a user with Administrator access.
- 5 Insert the driver CD in the PC's drive. When the Card Printer Installation window opens, click "Install the Printer."
- 6 Click Continue on the User Account Control dialog box.



- 7 On the License Agreement page, click "I accept the terms of the license agreement." to accept the license agreement and then click "Next."

Installation will not continue unless you accept the license agreement.

If the Visual C++ dialog appears, allow it to continue and close by itself. Do not Cancel it!

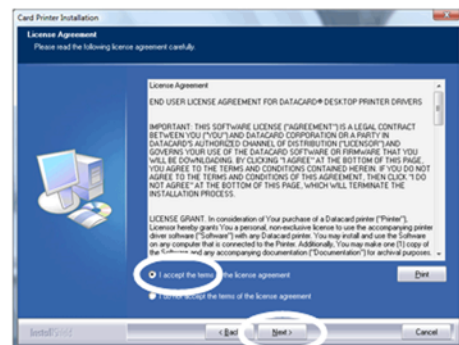

- 8 On the Install . . . page of the Card Printer Installation, click “Directly Networked Printer” and then click “Next.”

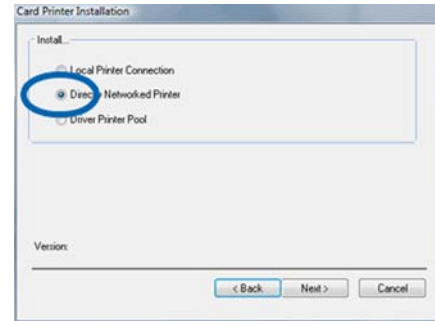

- 9 “Please Wait” appears on the PC, followed by the “The Card Printer is successfully installed on your PC.” message.

- 10 Click OK to close the message box.

- 11 Close the Properties dialog box for the printer if it appears.

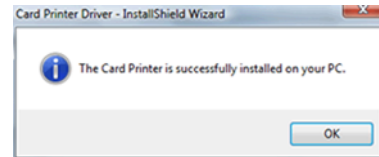

- 12 Open the Properties dialog box as an Administrator:

- a Choose Start > Control Panel > Hardware and Sound > Printer. The Printers window opens.
- b Click the icon for the printer to select it, and then right-click to display a popup menu.
- c Choose Run as Administrator > Properties on the popup menu.
- d Choose “Continue” on the User Account Control dialog box to open the Properties dialog box.

- 13 Choose the Advanced page of the Properties dialog box.

- 14 Choose the New Driver button to open the Add Printer Driver Wizard.

- 15 On the Add Printer wizard, click Next. Wait while Windows locates available drivers.

- 16 In the Manufacturer list, scroll to the brand of your card printer and select it.

- 17 In the Printers list, choose (brand) UniDir and then click Next.

- 18 The “Completing . . .” page of the Add Printer Driver Wizard appears. Click Finish.

- 19 After the PC completes the change to the new driver, the Wizard closes and the new driver name appears in the Driver box of the Advanced page of Properties.

- 20 Click OK to close Properties. The driver displays a message to restart the computer. Click OK to close the message and close any other windows open.

- 21 Restart Windows.

- 22 Power the printer off and then on.

- 23 Choose Start > Control Panel > Hardware and Sound > Printers. The Printers window opens.

- 24 Open the Properties dialog box for the printer as an Administrator:

- a Click the icon for the printer to select it, and then right-click to display a popup menu.
- b Choose Run as Administrator > Properties on the popup menu.
- c Choose “Continue” on the User Account Control dialog box to open the Properties dialog box.

25 Choose the Ports tab, click once on the port for the printer, and then click the Configure Port button.

26 Click once in the Enter Network Address box to activate it.

27 Enter the name of the network adapter (if used) or IP address of the printer.

28 Click the Test button. Wait to see the "Successfully communicated . . ." message and then click OK to close the message. If the PC does not communicate with the printer, see "[Installation Troubleshooting](#)".

29 Click OK to close the Enter Network Address dialog box. Close Properties.

30 Choose File > Printing Preferences to open the Printing Preferences dialog box.

- Choose the orientation for the card.
- Choose whether to print on both sides (a duplex module is required).

31 Click the "Advanced" button to open the Advanced page.

32 Change the Printer Type setting to match the printer installed.

33 Click OK on the Advanced page and the Printing Preferences page to close them.

34 Open the Advanced page of Printing Preferences again. (The Printer Type setting might change the choices available.)

35 The default Print Ribbon Type is YMCKT. If a different type of ribbon is installed in the printer, change the Ribbon Type.

36 Change other settings, such as Duplex Method or Mag stripe settings, if needed to match the printer. Close the Printing Preferences dialog box.

37 Open the Properties dialog again:

- a Click the icon for the printer to select it, then right-click to display a popup menu.
- b Choose Properties on the popup menu. (Do not choose "Run as administrator" this time.)

38 On the General tab of the Properties dialog box, click Print Test Page to print the Windows test page.

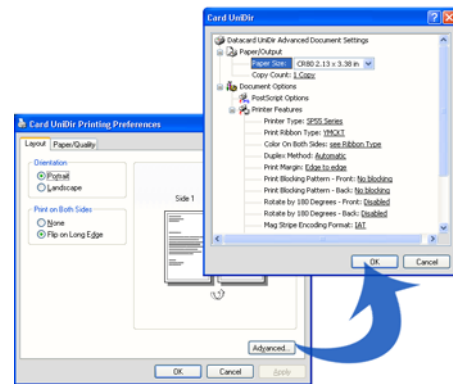
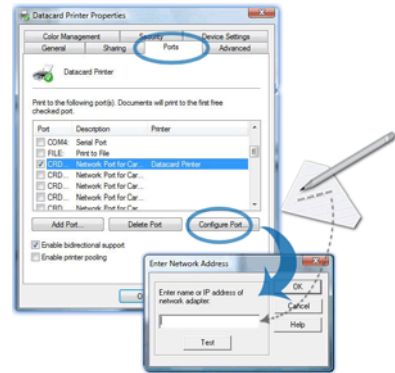

- 39 Verify that the Windows test page prints. The image on the card is likely to be cropped; this is expected.
 - 40 Click Close when the card prints, and then close the Properties dialog box.
- If you have not restarted the PC and the printer, the Windows test page might not print or might cause an error at the printer. Restart the printer: Do not follow Windows troubleshooting.



To continue, see "[Set up the Unidirectional Printer](#)".

Local USB Unidirectional Installation for Windows XP & Windows Server 2003



This installation is possible only on PCs running Windows XP or Windows Server 2003.

- 1 Load supplies and then power on the printer. See "[Preparing the Printer](#)" for the steps to follow.
- 2 Insert the driver CD in the PC's drive. When the Card Printer Installation window opens, click "Exit" to close the window.
- 3 Connect the printer to the PC using the USB data cable. The Found New Hardware wizard opens.
- 4 Click "No, not this time." and then "Next" to continue.
- 5 Choose to install the driver from a list or from a specific location and then click "Next."
- 6 Choose "Do not search..." and then click "Next."
- 7 On the Hardware Type window, choose "Printers" and then click "Next."
- 8 On the Add Printer Wizard window, click the "Have Disk" button. Browse to the driver CD and choose the CardPrinter.INF file.
- 9 Click "Open" and "OK" as needed to continue.

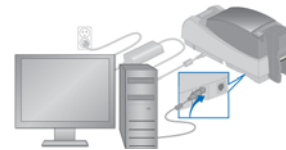

- 10 If needed, de-select "Show compatible hardware" to display more entries in the Printers list.

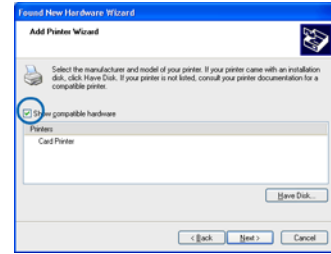

- 11 From the list of available drivers, choose the unidirectional driver. The name includes Unidirectional, Unidir, or a similar word.

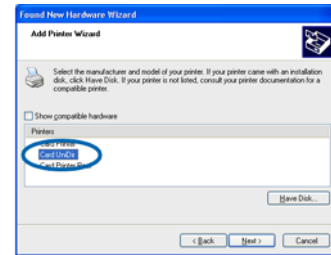

- 12 Click "Next" and follow the prompts to continue.

- 13 Click "Finish" to complete driver installation.

- 14 Power the printer off and then on.

- 15 Restart Windows.



- 16 Do one of the following to open the Printers window:

- For Windows XP, choose Start > Settings > Printers and Faxes.
- For Windows Server 2003 and some XP installations, choose Start > Printers and Faxes.

- 17 In the Printers window, click on the icon for the installed unidirectional printer.

- 18 Choose File > Printing Preferences to open the Printing Preferences dialog box.

- Choose the orientation for the card.
- Choose whether to print on both sides (a duplex module is required).

- 19 Click the "Advanced" button to open the Advanced page.

- 20 Change the Printer Type setting to match the printer installed.

- 21 Click OK on the Advanced page and the Printing Preferences page to close them.

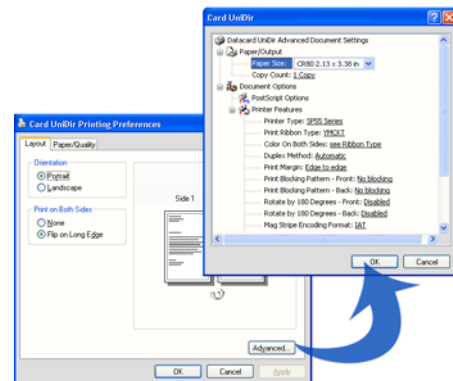

- 22 Open the Advanced page of Printing Preferences again. (The Printer Type setting might change the choices available.)

- 23 The default Print Ribbon Type is YMCKT. If a different type of ribbon is installed in the printer, change the Ribbon Type.

- 24 Change other settings, such as Duplex Method or Mag stripe settings, if needed to match the printer. Close the Printing Preferences dialog box.

- 25 With the printer icon highlighted, choose File > Properties to open the Properties dialog box.
- 26 On the General tab of the Properties dialog box, click Print Test Page to print the Windows test page.
- 27 Verify that the Windows test page prints. The image on the card is likely to be cropped; this is expected.
- 28 Click OK when the card prints, and then close the Properties dialog box.

If you have not restarted the PC and the printer, the Windows test page might not print or might cause an error at the printer. Restart the printer: Do not follow Windows troubleshooting.

To continue, see "[Set up the Unidirectional Printer](#)".



Local USB Unidirectional Installation for Windows 7, Windows Vista & Windows Server 2008



This installation is possible only on PCs running Windows 7, Windows Vista or Server 2008 operating systems.

- 1 Load supplies and then power on the printer. See "[Preparing the Printer](#)" for the steps to follow.
- 2 Insert the driver CD in the PC's drive. Click "Install the Printer" on the opening screen.
- 3 Click Continue on the User Account Control dialog box.



- 4 On the License Agreement page, click "I accept the terms of the license agreement." to accept the license agreement and then click Next.

Installation will not continue unless you accept the license agreement.

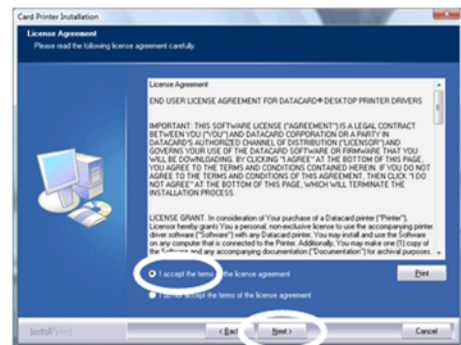

- 5 On the Install . . . page of Card Printer Installation, click “Local Printer Connection” and then click Next.
- 6 “Please Wait” appears on the PC, followed by the Install . . . page.

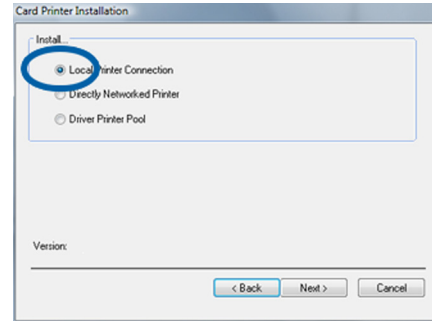

- 7 Connect the USB cable to the PC and the printer.

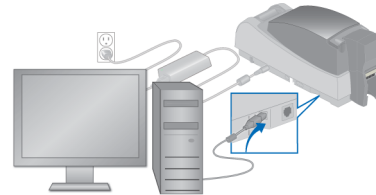

- 8 “Wait for Installation to complete” appears, followed by the “The Card Printer is successfully installed on your PC.” message.
- 9 Click OK to close the message box.

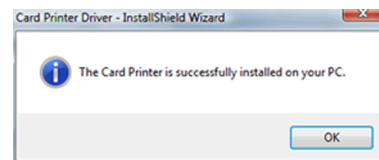

- 10 Continue to install the driver for the type of operating system installed on the PC:

Windows 7 and Windows Vista

- a Open the Printers window:

Windows 7

Choose Start > Devices and Printers

Windows Vista

Choose Start > Control Panel > Hardware and Sound > Printers

- b Click the icon for the printer to select it, then right-click to display a popup menu.

Windows 7

Choose Properties

Windows Vista

- i. Choose Run as Administrator > Properties on the popup menu.
- ii. Choose Continue on the User Account Control dialog box to open the Properties window.

- c Choose the Advanced page of the Properties window.

- d Click the New Driver button to open the Add Printer Driver Wizard.

- e On the Add Printer Driver Wizard, click Next. Wait while Windows locates available drivers.

- i. In the Manufacturer list, scroll to the brand of your card printer and select it.
- ii. In the Printers list, choose UniDir and then click Next.
- iii. The "Completing . . ." page of the Add Printer Driver Wizard appears. Click Finish.

- f After the PC completes the change to the new driver, the Wizard closes and the new driver name appears in the Driver box of the Advanced page of Properties.
- g Click OK to close Properties. The driver displays a message to restart the computer.
- h Click OK to close the message and close any other windows open.
- i Restart Windows
- j After Windows restarts, open the Printers window:

Windows 7

Choose Start > Devices and Printers

Windows Vista

Choose Start > Control Panel > Hardware and Sound > Printers

- i. Click the icon for the printer to select it, then right-click to display a popup menu.
 - ii. Choose Printing Preferences to open the Printing Preferences dialog box.
 - iii. Choose the orientation for the card.
 - iv. Choose whether to print on both sides (a duplex module is required).
 - v. Click the "Advanced" button to open the Advanced page.
 - vi. Change the Printer Type setting to match the printer installed.
 - vii. Click OK on the Advanced page and the Printing Preferences page to close them.
- k Open the Advanced page of Printing Preferences again. (The Printer Type setting might change the choices available.)
 - l The default Print Ribbon Type is YMCKT. If a different type of ribbon is installed in the printer, change the Ribbon Type.
 - i. Change other settings, such as Duplex Method or Mag stripe settings, if needed to match the printer.
 - ii. Click OK and Close as needed to close the Printing Preferences dialog box.
 - m Open the Properties window again:
 - i. On the General tab, click the Print Test Page button.
 - ii. Verify that the Windows test page prints. The image on the card is likely to be cropped; this is expected.
 - iii. Click OK when the card prints, and then close the Properties dialog box.
 - iv. If you have not restarted the PC and the printer, the Windows test page might not print or might cause an error at the printer. Restart the printer: Do not follow Windows troubleshooting.

Windows Server 2008

- a Change the User Account Control settings
 - i. Navigate to Control Panel> System and Security> Action Center> Change User Account Control Set.
 - ii. Set the control level to the lowest setting by sliding the bar down.
 - iii. Close the User Account Control settings window.
- b Restart the PC.
- c Open Printer Properties
- d Choose the Advanced tab.
- e Choose the New Driver button to open the Add Printer Driver Wizard.

- f** On the Add Printer Driver Wizard, click Next. Wait while Windows locates available drivers.
 - i. In the Manufacturer list, scroll to the brand of your card printer and select it.
 - ii. In the Printers list, choose UniDir and then click Next.
 - iii. The "Completing . . ." page of the Add Printer Driver Wizard appears. Click Finish.
 - g** After the PC completes the change to the new driver, the Wizard closes and the new driver name appears in the Driver box on the Advanced page of Properties.
 - h** Click OK to close Properties. The driver displays a message to restart the computer.
 - i** Click OK to close the message and close any other windows open.
 - j** Restart the PC. You may want to return the User Account Control settings (changed in "Step a") to their previous setting before restarting the PC.
 - k** Open Printing Preferences.
 - i. Choose Start > Control Panel > Hardware and Sound > Printers. The Printers window opens.
 - ii. Click the icon for the printer to select it, then right-click to display a popup menu.
 - iii. Choose Printing Preferences.
 - iv. Set the orientation for the card to either portrait or landscape.
 - v. Choose whether to print on both sides (a duplex module is required).
 - vi. Click the "Advanced" button to open the Advanced page.
 - vii. Change the Printer Type setting to match the printer installed.
 - viii. Click OK on the Advanced page and the Printing Preferences page to close them.
 - l** Open the Advanced page of Printing Preferences again. (The Printer Type setting might change the choices available.)
 - m** The default Print Ribbon Type is YMCKT. If a different type of ribbon is installed in the printer, change the Ribbon Type.
 - i. Change other settings, such as Duplex Method or Mag stripe settings, if needed to match the printer.
 - ii. Click OK and Close as needed to close the Printing Preferences dialog box.
 - n** Open Printer Properties again:
 - i. In the Printers window, click the icon for the printer to select it.
 - ii. Right-click to display a popup menu.
 - iii. Choose Properties on the popup menu.
 - iv. On the General tab, click the Print Test Page button.
 - v. Verify that the Windows test page prints. The image on the card is likely to be cropped; this is expected.
 - vi. Click OK when the card prints, and then close the Properties dialog box.
 - vii. If you have not restarted the PC and the printer, the Windows test page might not print or might cause an error at the printer. Restart the printer: Do not follow Windows troubleshooting.
- 11** To continue, see ["Set up the Unidirectional Printer"](#).

Set up the Unidirectional Printer



Before using the printer, verify or change printer settings at the server PC. See *InfoCentral* for information about settings. The setting you choose affects all clients that send print jobs to this printer:

- 1 Set the Printer Type to match the name plate on the printer.
- 2 Set the Ribbon Type to match the ribbon installed in the printer.
- 3 Set the Print on Both Sides setting, which controls whether the printer prints one side or two sides. Also set the Duplex method, which controls how two-sided printing occurs. (Manual duplex is not supported.)
- 4 For printing two-sided (duplex) cards and some ribbon types, set whether to print color on both sides.
- 5 Set print and topcoat blocking, if needed. For manual-feed printers, set rewrite blocking if needed.
- 6 If the printer includes a magnetic stripe option and you will be printing magnetic stripe cards, set mag stripe encoding values.
- 7 Set whether to apply Laminator material to one or both sides of the card (available only on laminating printers).
- 8 Set card design features, such as portrait or landscape orientation.

Features provided by the Printer Toolbox, including color settings, supplies information, edge-to-edge settings, and printhead power, are not available using a unidirectional driver. Diagnostics for Card Printers does not run with a unidirectional driver. The Firmware Update program does not run with a unidirectional driver. See "[Firmware Updates](#)" for information about updating firmware.

See "[Printing Cards in the Windows Terminal Services Environment](#)".

Printing Cards in the Windows Terminal Services Environment



In controlled network environments, Windows Terminal Services makes resources on the server available to client PCs on the network. These resources can include applications, data, and printers. The unidirectional driver can be installed in the Windows Terminal Services environment, as described in "[Installing the Unidirectional Driver](#)".

Features

Many driver features are not available when using the unidirectional driver. If you need one or more of these features on a regular basis, and the printer does not include an LCD panel, consider whether to install the bidirectional driver to another PC, and change the printer connection from the server to the PC for short periods of time. You cannot have a unidirectional driver and a bidirectional driver installed on the same PC.

The following features are not available using the unidirectional driver but there are alternative methods for the feature:

- The Printer Toolbox for the unidirectional driver does not open, which has the following impacts:

- The Start > Programs > Card Printers > Card Printer entry has no effect when it is chosen.
- Messages are not displayed on the PC when the printer has an error. If the printer has an LCD panel, messages are displayed on the panel and can be cleared using the keys on the LCD panel.

If the printer does not have an LCD panel, you cannot receive information about the cause of the error. Investigate the likely causes, such as a being out of cards, out of ribbon, or having a jammed card.

- The Retry button and the message box are not displayed. The card in process must be sent from the PC to print again.
- Card counts are not available. If the printer has an LCD panel, view card counts on the LCD panel. If the printer does not have an LCD panel, you can connect the printer to another PC using bidirectional communication. The driver will obtain the values when you open the Printing Preferences dialog box or the Printer Toolbox (depending on the printer driver version).
- The Sample Card and Magnetic Stripe Sample Card buttons on the Printer Toolbox are not available (because the Printer Toolbox does not open). The printer can be connected to another PC using bidirectional communication to use these buttons.
- The Clean Printer and Clean Laminator buttons on the Printer Toolbox are not available (because the Printer Toolbox does not open). If the printer has an LCD panel, use it to run the printer cleaning cards. If needed, the printer can be connected to another PC using bidirectional communication to use these buttons.
- Edge-to-edge settings on the Printer Toolbox are not available (because the Printer Toolbox does not open). Usually, this setting is changed only when installing a new printhead cartridge. The printer can be connected to another PC using bidirectional communication to change edge-to-edge settings, which will be saved in the printer.
- The PC cannot automatically detect the type of printer or printer features, such as a duplex module. Open Printing Preferences and set the printer type to match the printer. Close Printing Preferences and open again to make changes based on the printer type, such as print ribbons available.
- The PC cannot automatically detect the type of print ribbon. Open Printing Preferences and set the ribbon type to match the ribbon installed in the printer.
- The unidirectional printer cannot be selected in Diagnostics for Card Printers. The printer can be connected to another PC using bidirectional communication to use Diagnostics.
- The Firmware Update Program does not open. The printer can be connected to another PC using bidirectional communication to use the Firmware Update Program.

The following features are not available and an alternative is not available:

- The Color Settings Tab on the Printer Toolbox cannot be used and there is no method for changing color settings in the driver.
- Manual duplex (for simplex printers) is not available.
- Printing multiple copies of the same card design, using the “Copies” setting in Printing Preferences, is not supported.
- Security features are not available.
- Interactive mode, including processing smart cards and reading magnetic stripe data, is not available.

Installation Troubleshooting

The card printer does not install when the USB cable is connected



If the printer is not recognized correctly by the PC, or if the installation was interrupted, the Device Manager might have an entry for the printer that needs to be removed before the printer can be installed. The following instructions apply to Windows XP.

- 1 Disconnect the printer from the PC.
- 2 If the printer was installed, make sure it is deleted. See ["Removing the Existing Driver"](#).
- 3 Choose Start > Settings > Control Panel. The Control Panel window opens.
- 4 On the Control Panel, choose System to open the System Properties dialog box.
- 5 Choose the Hardware page, and then click the Device Manager button. The Device Manager window opens.
- 6 In the View menu, make sure "View devices by type" is selected.
- 7 Locate the device to delete. The device might be called "Unknown device" or it might be located under the Printers folder. The device might be marked with a yellow question mark or exclamation mark.
- 8 Click on the device name to select it, and then right-click to display a pop-up menu.
- 9 Choose Remove from the pop-up menu.
- 10 Click Yes or OK to confirm removal of the device.
- 11 Close the Device Manager. Close any other windows.
- 12 Return to the procedure you were performing.

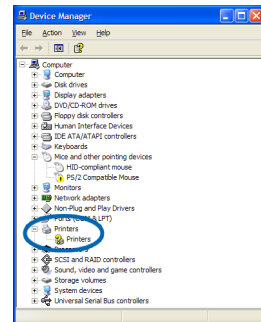

See *InfoCentral > Troubleshooting > Installation* for the steps for the Windows Vista operating system.

A message appears when installing a second or subsequent printer on one PC



If the Printer Toolbox for an installed printer is active when an additional printer is installed, the additional printer does not install correctly. Follow these steps:

- 1 Follow the steps in ["The card printer does not install when the USB cable is connected"](#) to remove the additional printer from the PC.
- 2 Exit the Printer Toolbox for all installed printers:
 - a Right-click the printer icon in the task bar to display a pop-up menu.
 - b Choose Exit from the menu.
- 3 Start installation for the additional printer again.

Cards sent by a user do not print



The PC can appear to have problems when the user does not have the necessary permissions to use the printer. To set permissions, see *InfoCentral > Advanced > Printer Permissions*.

The Print Sample Card button is gray



The Print Sample Card button in the Printer Toolbox is enabled when the printer and driver communicate normally. If the Print Sample Card is gray, check the following:

- The printer is suspended. Click the Resume button.
- The printer is busy processing a print job sent by another user on the network.
- The printer is paused. Check that the Status Light on the front of the printer is steady green.

For additional troubleshooting, see *InfoCentral > Troubleshooting > Communication*.



Set up Printer Pooling



Setting up a printer pool has two components:

- "Installing Each Printer"
- "Installing the Printer Pool Driver"

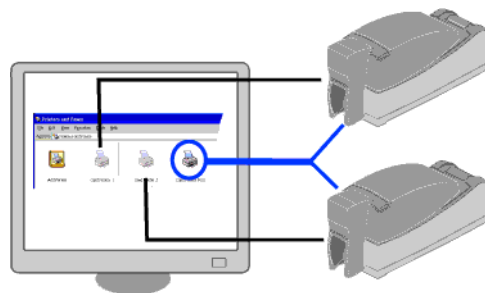

Installing Each Printer

First, install the physical printers. To install each printer:

- 1 Install the same type of supplies in each printer. See ["Installing Supplies and Powering on the Printer"](#) for the steps to follow.

You must install the same ribbon type in each printer for the card data to be processed (rendered) correctly by the driver and for each printer to accept any card sent.

- 2 Install each printer and its driver on the PC. See ["Installation on Windows"](#) for the steps to install a local (USB) or network printer.

- 3 Set up each printer with the same settings, especially print on both sides, magnetic stripe settings, and laminate "apply material."

The print ribbon type is set based on the print ribbon actually installed in the printer and cannot be changed.

- 4 Verify the operation of each printer on its own.

Installing the Printer Pool Driver

After each printer is installed and working correctly, install the printer pool driver. This is a "logical" printer to which the application sends jobs.

- 1 Install the printer pool driver. Start the driver installation program by doing one of the following:

— Insert the driver CD in the PC's drive. When the dialog box appears, click "Install the Printer".

— If you downloaded the installation file from the Web site, double-click the file to start the installation program.

- 2 For Windows Vista, click "Continue" on the User Account Control dialog box if it appears.



3 The Card Printer Installation dialog box appears.

4 Click the "I accept the terms of the license agreement" button and then click "Next."

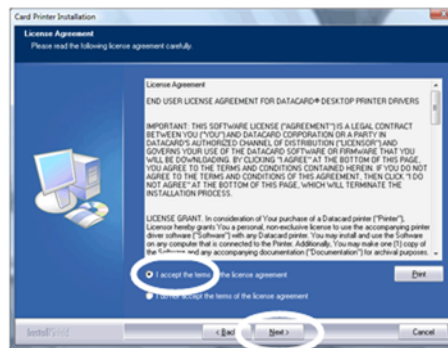

5 The installation begins.

6 Choose "Driver Printer Pool" from the list and click Next.

7 The installation program runs to install the printer pool.

8 Restart Windows.

9 After Windows restarts, do one of the following to open the Printer's window:

— For some Windows XP installations, choose Start > Settings > Printers and Faxes.

— For Windows Server 2003 and some XP installations, choose Start > Printers and Faxes.

— For Windows Vista and Windows Server 2008, choose Start > Control Panel > Hardware and Sound > Printers.

10 Right-click on the printer icon for the pool and choose Printing Preferences from the pop-up menu.

— Set "Print on both Sides" if enabled, to "None" for cards printed on one side, or "Flip on Long Edge" for two-sided cards.

— Set the orientation for cards.



- 11 Click the Advanced button.
- 12 In the Advanced Options window, choose or verify the following:
 - Set the Printer Type to be the same as the printers in the pool.
 - Set the Print Ribbon to the type of ribbon installed in all printers.
 - Set the duplex method to None for cards printed on one side or Automatic for two-sided cards. (Manual is not supported.)
 - Choose other settings to use the same values as each printer uses.
- 13 Click OK to close the Advanced Options and Printing Preferences dialog boxes.
- 14 Verify the operation of the printer pool.
- 15 In the application you use, choose the printer pool as the printer.

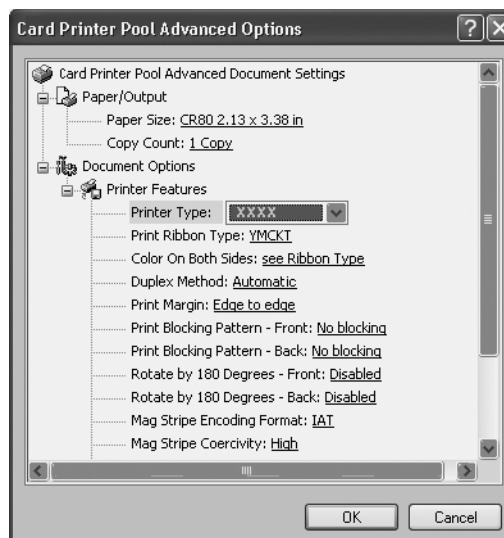

If you have a card printer that you want to remove from the pool, see the *Solutions Guide* or ask your service provider.

See "[Printing Cards Using a Printer Pool](#)" for information about printing to a printer pool.

Printing Cards Using a Printer Pool



Printer pooling is a feature of the Windows 7, Windows Vista and Windows XP operating systems. A printer pool treats a group of printers as one printer and distributes print jobs among the available printers.

Begin with the PC powered on and the driver and printer pool installed.

Tips for Success

- To use the printer pool effectively, each card must be sent from the application as a separate job. Some applications, such as ID software, send each card in a batch as a separate job, while others send the batch as one job. Test the application you use to determine the best way to send multiple cards to the printer pool.
- The printer pool determines whether printers are available:
 - If you do not want one or more printers to print cards as part of the pool, suspend the printer in Print Manager. Check this each time you power on the PC.
 - ◁ Choose Start > Settings > Printers and Faxes to display the Printers windows. For Windows Vista, choose Start > Control Panel > Hardware and Sound > Printer.
 - ◁ Click once on the printer to select it.
 - ◁ Right-click the printer to display the popup menu.
 - ◁ Choose Pause Printing from the popup menu.

- The printer pool will identify a USB-connected printer as “available” even when the printer status is Suspended or Not Responding if the printer is powered on. Power off a USB-connected printer to remove it from the pool or suspend printing using Print Manager.
- A network printer will not be identified as “not responding” until one card is sent and not accepted by the printer. Suspend the printer in Print Manager.
- If the Printer Toolbox for a printer is in Advanced Setup, the printer is not available.
- If you need to use a printer separately from the printer pool, install it on another PC or contact your service provider for assistance in removing it from the pool.
- Some applications track card completion status, and this data is available for cards sent to the printer pool. The application can query the printer pool and obtain status for all cards processed through the pool. Card completion status does not indicate which printer actually printed the job.
- In the Printing Preferences dialog box for the printer pool, select the printer type, the ribbon type, the Apply material setting for laminating printers, and other settings that apply to all cards.
- For magnetic stripe encoding, use the same coercivity and magnetic stripe format values for all printers and the printer pool. (If you select "Use printer settings," make sure the settings in the printers are the same; use Diagnostics for Card Printers to view magnetic stripe values if needed.)

Using a Printer Pool

To use a printer pool:

- 1 Make sure that all printers you want to receive card data and print cards have the same type of supplies loaded and the same settings.
- 2 Make sure that the printer pool settings match the printer settings.
 - For example, if you print color and encode magnetic stripe, load YMCKT ribbon in the printers and use high-coercivity magnetic stripe cards. Each printer identifies the ribbon type as YMCKT, but the pool cannot identify the Print Ribbon Type so you must set the type.
- 3 Make sure the printers are powered on and ready.
- 4 In the application used to print cards, select the name assigned to the printer pool when it was installed, such as Card Printer Pool.
- 5 Select Print in the application. The application sends the cards to the printer pool, which randomly distributes the card jobs among the available card printers. When all printers are busy, the printer pool keeps the card jobs in a queue until the next printer is not busy. It will send the next card job as soon as any printer in the pool is available.

A printer is available if:

- The number of jobs active in the printer is less than the number of jobs supported for that printer type.
- No jobs are pending in the Windows spooler for that printer.
- The printer is not paused in Windows Print Manager.
- The printer is not set to "work offline" in Windows Print Manager
- The printer status displayed in Windows Print Manager is not "User Intervention Required."
- The Printer Toolbox is not in Advanced Setup mode.

- 6 After a card is sent by the printer pool to a specific printer, it cannot be removed from that printer and assigned to another printer.
 - When a printer issues a message, the message appears on the PC with the name of the printer in the title bar of the message box. The printer will be unavailable to print cards until the situation causing the message is corrected. Other printers in the pool will continue to receive card jobs and print cards.



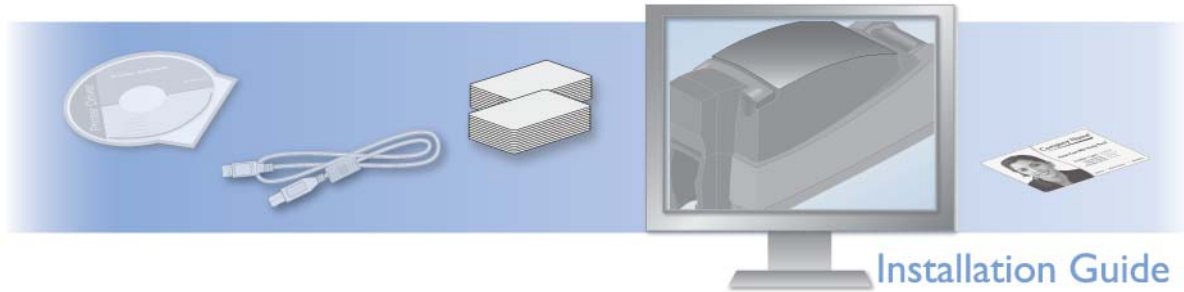

Shared Printers

This section provides information about printing over a network using Microsoft File and Printer Sharing. A printer is connected to a PC (host) that has the printer driver installed. After you share the printer, users at other PCs (Clients) on the network can print to it. Up to 10 Client PCs can share the printer at one time. Users at Client PCs do not have the same level of access to the printer driver as a user at the Host PC.

The following operating system configurations are supported:

- Both the Host PC and the Client PC must have the same type of processor (either 32- or 64-bit) installed.
- Both the Client and Host PCs run Windows XP. See "[Printer Sharing for Windows XP or Windows Server 2003](#)".
- Both the Client and Host PCs run Windows Vista. See "[Printer Sharing for Windows Vista Client PCs](#)".
- Both the Client and Host PCs run Windows 7. See "[Printer Sharing for Windows 7 PCs](#)".
- The Host PC runs Windows Server 2003 and the Client PCs run Windows XP or Windows Vista.
- The Host PC runs Windows Server 2008 and the Client PCs run Windows XP or Windows Vista.

See "[Printing Cards Using a Shared Printer](#)" to use and manage the printer.

See "[Updating the Driver When Sharing Printers](#)" if you need to update the driver when sharing printers.

Components

This section describes the components you need to use the card printer with printer sharing.

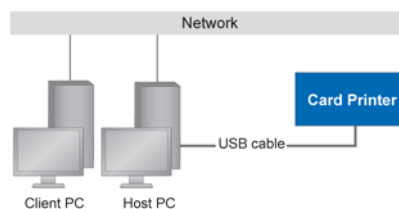

Network: A TCP/IP compatible network must be set up and working before you begin.

Host PC: The PC with the printer attached is called the Host PC. The Host PC must be connected to the network, and have permissions for users set.

Port connection: The printer can be connected to the Host PC through a USB port or a direct network connection.

Client PC: The Client PC is connected to the Host PC over the network.

Setting up Printer Sharing

Requirements for Printer Sharing



The requirements depend on the operating system of the Host PC.

Requirements for Printer Sharing on a Windows Server 2003 or 2008 Host PC

Before sharing a printer attached to a Windows Server Host PC over the network, meet the following requirements:

- Each PC that uses the printer must have a working network connection. Verify the network connection is working properly.
- Each PC that uses the printer must have a supported Windows operating system installed and have service packs required by the Host PC operating system.
- The printer at the Host PC must be enabled for sharing. See Windows help for information on enabling printer sharing.
- The PC with the printer attached (Host PC) must remain on, and the Windows operating system must be running. A user with Print, Manage Printers, and Manage Documents permissions to the printer must be logged on at the Host PC so that other users can print, and so the printer can be installed on the Client PC.
- If more than one printer is connected to a PC (including a shared printer) the printers must have different names.
- Set permissions for users at the Client PC and permissions for users at the Host PC. See *InfoCentral > Advanced > Printer Permissions* for the steps to follow.
- If a Client PC will have more than one shared printer installed, install one printer on the Host PC, and then install the printer on the Client PC. Complete the work of installing the printer on both Host and Client PCs, and then begin installation of the additional printer on the Host PC and the Client PC.
- A printer pool cannot be shared.

Requirements for Printer Sharing on a Windows XP Host PC

Before sharing a printer attached to a Windows XP Host PC over the network, meet the following requirements:

- Each PC that uses the printer must have the same Windows operating system and service packs installed.
- The printer at the Host PC must be enabled for sharing. See Windows help for information on enabling printer sharing.

- The PC with the printer attached (Host PC) must remain on, and the Windows operating system must be running. A user with Print, Manage Printers, and Manage Documents permissions to the printer must be logged on at the Host PC so that other users can print (and so the printer can be installed on the Client PC.)
- If more than one printer is connected to a PC (including a shared printer) the printers must have different names.
- Set permissions for users at the Client PC and permissions for users at the Host PC. See *InfoCentral > Advanced > Printer Permissions* for the steps to follow.
- If a Client PC will have more than one shared printer installed, install one printer on the Host PC, and then install the printer on the Client PC. Complete the work of installing the printer on both Host and Client PCs, and then begin installation of the additional printer on the Host PC and the Client PC.
- A printer pool cannot be shared.

Requirements for Printer Sharing with a Windows Vista Host PC

Before sharing a printer attached to a Windows Vista Host PC over the network, meet the following requirements:

- Each PC that uses the printer must have a working network connection.
- Each PC that uses the printer must have the same Windows Vista® operating system and service packs installed.
- The printer at the Host PC must be enabled for sharing.
- The PC with the printer attached (Host PC) must remain powered on and the Windows Vista® operating system must be running. A user with Print, Manage Printers, and Manage Documents permissions must be logged on at the Host PC so that other users can print, and so the printer can be installed on the Client PC.
- If more than one printer is connected to a PC (including a shared printer), the printers must have different names.
- The first user who installs the printer on the Client PC must have Administrator permission on that PC.
- On the Client PC, the user who prints must be the same as the user who installed the printer.
- Each user must install the printer separately to be able to print.
- If a Client PC will have more than one printer installed, complete installation and setup (at both Client and Host PCs) for one printer before beginning installation of any subsequent printers.
- A printer pool cannot be shared.

Requirements for Printer Sharing with a Windows XP Client PC

Before sharing a printer over the network to a Windows XP Client PC, meet the following requirements:

- Each PC that uses the printer must have a working network connection. Verify that the network connection is working properly.
- The Windows XP Client PC can connect to a Host PC running the Windows XP, Windows Server 2003, or Windows Server 2008 operating system.
- If more than one printer is connected to a PC (including a shared printer), the printers must have different names.

- A printer pool cannot be shared.

Requirements for Printer Sharing with a Windows Vista Client PC

Before sharing a printer over the network to a Windows Vista Client PC, meet the following requirements:

- Each PC that uses the printer must have a working network connection. Verify the network connection is working properly.
- The Windows Vista Client PC can connect to a Host PC running the Windows Vista, Windows Server 2003, or Windows Server 2008 operating system.
- If more than one printer is connected to a PC (including a shared printer), the printers must have different names.
- The first user who installs the printer on the Client PC must have Administrator permission on that PC.
- On the Client PC, the user who prints must be the same as the user who installed the printer.
- Each user must install the printer separately to be able to print.
- A printer pool cannot be shared.

Printer Sharing for Windows XP or Windows Server 2003

Setting up the Host PC for Windows XP and Windows Server 2003



To set up the Host PC for printer sharing, do the following:

- 1 Install the printer driver on the Host PC. See ["Installing the Driver with Bidirectional Communication"](#) for more information.
- 2 With the printer power on, change settings to reflect your card design, including printer features such as ribbon type and magnetic stripe settings. Record the settings so you can also make those settings on the Client PC.
- 3 Change the printer name to meet the following requirements:
 - The name of a shared printer is the name you assign plus the server name (which is added by Windows). The server name is the network name of the Host PC.
 - The printer name cannot contain spaces or special characters. Search for "rename printer" in Windows help for more information.
 - For best results, use a name with 8 or fewer characters.
 - The printer name, including the server name, must be fewer than 31 characters.
 - See Windows help for "printer name" or "computer name" for allowed characters and naming guidelines.
- 4 Restart Windows on the Host PC.
- 5 Enable the printer for sharing:
 - a From the Windows Start menu, choose Settings > Printers and Faxes to open the Printers window.
 - b Click the printer icon to select it, and then right-click to display the popup menu.
 - c Choose Sharing from the popup menu to open the Sharing page of the Properties dialog box for the printer.

- d Click the “Share this printer” checkbox and the first 8 characters of the printer name automatically appears in the Share name box.
 - e Complete the printer name.
 - f Click Apply and then OK. Notice that the icon for the shared printer now includes a shared symbol.
- 6 Set up an account for each user at the Host PC.
 - Set up accounts for users who log onto the Host PC and for users who log onto the Client PC(s).
 - 7 Grant users' permission to the printer from the Host PC, including:
 - Client PC users who have Print permission to the printer.
 - Host PC users who also have Print, Manage Printers, and Manage Documents permissions to the printer.
 - Host PC users (if any) who are denied permission to the printer.
 - See *InfoCentral > Advanced > Permissions* for the steps to follow.
 - 8 Make sure Client PC users can access the Host PC from the network.

Setting up the Windows XP Client PC



- 1 Set up an account for each user of the Client PC.
 - You need at least one user with administrator access to both Client and Host PCs to install the driver.
- 2 Make sure Client PC users can access the Host PC from the network.

Installing the Printer Driver on the Client PC for Windows XP



Tips for Success

- If another card printer is installed on the PC, see ["Driver Co-existence on Windows"](#) for information on compatibility.
- A PC can have a locally connected (USB) card printer attached, a directly networked card printer attached, and be connected to a shared printer as a Client PC.
- If you use more than one connection method on a PC, install the locally and/or directly-networked printer(s), and then follow the steps in this section to install the shared printer last. The shared printer must have a different name from the other printers.
- See Windows help for “printer name” for rules about names for printers, including shared printers.
- If you update the printer driver on the Host PC, you need to remove the driver from the Client PC and install it again. See ["Removing a Printer from a Windows PC"](#) for more information.

Follow the steps in this section and then restart Windows before printing from the Client PC.

- 1 Make sure that the printer and driver on the Host PC are working properly before beginning this task.
- 2 Start Windows at the Client PC, logging in as an administrator, and log onto the network.
- 3 Use Windows Explorer, Network Neighborhood, My Network Places, or My Computer to locate the Host PC on the network.
- 4 When you locate the Host PC, log into it using the user name and password defined on the Host PC. Keep the window open during printer driver installation.

- 5 Click Start > Settings > Printers and Faxes to open the Printers and Faxes window.
- 6 Choose File > Add Printer from Printers window menu bar. The Add Printer wizard starts.
- 7 In the Add Printer wizard, select the following choices:
 - Choose the "Network printer" or "Network printer, or a printer attached to another computer", *not* "My Computer" or "Local printer."
 - Choose to browse for the printer. An expandable list of network servers, PCs, and/or printers appears.
 - If needed, double-click a server or PC name to see the names of printers attached.
 - Choose the printer to which the user will print. The printer name appears in the Printer box.
 - The printer name includes the name of the Host PC. Make sure the name of this printer is different from the names of any other printers attached to this PC.
 - Continue to follow the prompts on the Add Printer wizard.
 - Choose "Replace existing driver" if you are prompted.
 - Click No if you are prompted to print a test page. You must set values in the Printing Preferences dialog box before printing.
 - If you are prompted to restart Windows, continue with this procedure and do not restart the computer.
- 8 In the Printers and Faxes window, click the icon for the printer, and then choose File > Printing Preferences to open the Printing Preferences dialog box.
- 9 Change settings on the Client PC to match those on the Host PC and your card design. Some settings are read from the Host PC and can not be changed.
 - The Client PC obtains the Printer Type and Ribbon Type from the Host PC. If it cannot obtain the values from the Host PC, the Client PC will use the default values or the last set of values obtained from the Host PC.
 - Change settings that apply to the printer, such as magnetic stripe, so they are the same as those on Host PC and printer features.
 - Change settings to reflect your card design, such as portrait or landscape orientation. These settings can be different from the settings on the Host PC.
- 10 On the General tab of the Properties dialog box, click "Print Test Page" to print the Windows test page.
- 11 Verify that the Windows test page prints. The image on the card is likely to be cropped; this is expected.
- 12 Click OK when the card prints, and then close the Properties dialog box. Do not follow Windows troubleshooting.
- 13 Restart the Client PC.
- 14 Assign Print permission to the printer for Client PC users who will use the printer.

See ["Printing Cards Using a Shared Printer"](#) to use and manage the printer.



Printer Sharing for Windows Vista Client PCs

The 4.x Card Printer Driver supports printer sharing on Windows Vista Client PCs, using the procedures described in this section.

Set Up the Host PC for Printer Sharing on Windows Vista



- 1 Log in to the Host PC as a user with Administrator permissions.
- 2 Install the printer driver on the Host PC. See ["Installing the Driver with Bidirectional Communication"](#) for more information.
- 3 Rename the printer on the Host PC to use a short name with no spaces.
 - For best results, use a name with 8 or fewer characters.
 - See Windows help for "printer name" or "computer name" for allowed characters and naming guidelines.
- 4 Restart Windows on the Host PC and log in as a user with Administrator permissions.
- 5 Choose Control Panel > Hardware and Sound > Printers to open the Printers window.
- 6 Click the printer to select it and then right click and choose Sharing from the pop-up menu. The Properties dialog box opens to the Sharing tab.
- 7 Click the "Change Sharing Options" button.
- 8 Click "Continue" on the User Account Control warning.
- 9 Choose "Share this printer." The name assigned in step 3 appears in the Share Name box. Do not change this name.
- 10 Clear the "Render Print Jobs on Client Computers" checkbox.
- 11 Click "Apply" and then "OK" to save the settings and close the box.

When you share a printer, users at other PCs on the network can see the printer.

Printer Sharing for Windows 7 PCs

The 12.x Card Printer Driver supports printer sharing on Windows 7, using the procedures described in this section.

Set Up the Host PC for Printer Sharing on Windows 7



- 1 Install the printer on the host PC.
- 2 With the printer power on, change settings to reflect your card design, including printer features such as ribbon type and magnetic stripe settings. Record the setting so you can also make those settings on the client PC.
- 3 Rename the printer with a filename that contains no spaces.
- 4 Restart the host PC.
- 5 From the Windows Start menu, choose Devices and Printers. The Printers window opens.
- 6 Right click on the renamed printer and select Sharing. The Properties dialog box opens to the Sharing tab.
- 7 Click the Share this printer checkbox and the first eight characters of the printer name automatically appear in the Share name box.

- 8 Complete the printer name.
- 9 Click Apply and then OK. Notice that the icon for the shared printer now includes a shared symbol. Set up an account for each user of the host PC. Set up accounts for users who log onto the host PC and for users who log onto the client PC(s).
- 10 Grant users' permission to the printer from the host PC. For more information on setting permissions, see Printer Permissions.
- 11 Install the driver on the client PC.

Install the Driver on the Client PC, Windows 7



Use this process at the Client PC to install the printer. If more than one Client PC will share the printer, repeat the procedure at each Client PC.

- 1 Open Windows Explorer.
- 2 Expand the Network selection to locate the host PC on the network.
- 3 Log on to the host PC using the user name and password for the host PC. Keep the window open during driver installation.
- 4 From the Windows Start menu, click Devices and Printers to open the Printers window.
- 5 Choose File> Add Printer. The Add Printer wizard starts.
- 6 In the Add Printer wizard, select the following choices:
 - a Choose the "Network printer" or "Network printer, or a printer attached to another computer", not "My Computer" or "Local printer."
 - b Choose to browse for the printer. An expandable list of network servers, PCs, and/or printers appears.
- 7 If needed, double-click a server or PC name to see the names of printers attached.
- 8 Choose the printer to which the user will print. The printer name appears in the Printer box.
- 9 The printer name includes the name of the host PC. Make sure the name of this printer is different from the names of any other printers attached to this PC.
- 10 Continue to follow the prompts on the Add Printer wizard.
- 11 Choose "Replace existing driver" if you are prompted.
 - Click No if you are prompted to print a test page. You must set values in the Printing Preferences dialog box before printing.
 - If you are prompted to restart Windows, continue with this procedure and do not restart the computer.
- 12 In the Printers window, right click the icon for the shared printer and choose Printing Preferences to open the Printing Preferences dialog box.
- 13 Change the settings to match the settings of the host PC. Note that some settings are set from the host PC and cannot be changed from the client PC.
- 14 The client PC obtains the Printer Type and Ribbon Type from the host PC. If it cannot obtain the values from the host PC, the client PC will use the default values or the last set of values obtained from the host PC.
- 15 Change settings that apply to the printer, such as magnetic stripe, so they are the same as those on host PC and printer features. Change settings to reflect your card design, such as portrait or landscape orientation. These settings can be different from the settings on the host PC.

- 16 In the Printers window, right click the icon for the shared printer and choose Printer Properties to open the Properties dialog box.
- 17 Click the Print Test Page button on the General tab of the Properties dialog box and verify that the test page prints.
- 18 Restart the client PC.
- 19 Assign print permission to the printer for client PC users who will use the printer. See *InfoCentral>Advanced>Printer Permissions* for more information.

Tips for Success

- If the user who logs in at step 1 is not defined at the Host PC, they must enter a username and password defined on the Host PC at step 5.
- When the user restarts Windows on the Client PC, the user might need to connect to the Host PC and log in. This depends on the network setup and is more likely with Windows Vista and Windows Server 2008 operating systems.
- To install the printer for additional users, repeat the procedure. For step 1, a user with Print permission to the printer can install the driver after it has been installed by an Administrator.
- If a Connect to Printer dialog appears with a message similar to the one shown, restart Windows and repeat the procedure.

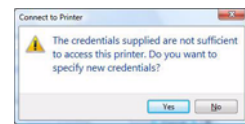

- The Start menu at the Client PC contains entries for the printer. The user who installed the printer can use them to open the Printer Toolbox and InfoCentral.

Printing Cards Using a Shared Printer



Microsoft File and Printer Sharing enables a user at one PC to print to a printer attached to another PC.

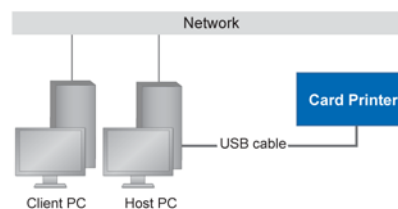

A printer is connected to a PC (Host) and has the printer driver installed. After you share the printer, users at other PCs (Clients) on the network can print to it. Up to 10 Client PCs can share the printer at one time. The driver is installed on the Host PC and then on each Client PC.

Using the Printer from the Client PC

Users at the Client PC can perform several actions, including:

- Print a card. At the Client PC, send cards to print from an application by selecting the printer in the application and then choosing Print.

- Print a card using an application and magnetic stripe fonts. When printing from an application such as Microsoft Word, text for magnetic stripe encoding can be formatted using the magnetic stripe fonts provided by the printer driver. See *InfoCentral > Advanced > Magnetic Stripe > Fonts* for more information.
- Change card design settings. Selecting a landscape or portrait card orientation is one of the settings that can be changed from the Client PC. Many settings are read from the Host PC and cannot be changed from the Client PC. Those settings are disabled (grayed out) at the Client PC.
- Pause or delete print jobs submitted from Print Manager. Client PC print jobs can be paused or deleted from the Print Manager. The card job remains in the print queue until it is sent to the printer (or deleted). See Windows help for information on using Print Manager.
- View the status of the Client PC. The Printer Toolbox is available on the Client PC. It displays the client status and a reminder that the Host PC provides messages and additional status information.
- Use the Color Settings tab of the Printer Toolbox. The color settings can be used to fine-tune the appearance of cards sent from the Client PC running Windows XP. For a Client PC running Windows Vista, the Color Settings at the Host PC are used for cards from the Client PC.
- View the Print Manager. The Status column in the Print Manager dialog box can be expanded to see messages from the Host PC.

Management Tasks at the Host PC

The user at the Host PC has more control over the printer and more information about the printer. This section describes some tasks performed at the Host PC.

- Print a card. At the Host PC, send cards to print from an application by selecting the printer in the application.
- Manage all jobs in the print queue. Use the Print Manager to view all jobs in the print queue and to pause or delete any jobs in the print queue, no matter who submitted the job. The job remains in the print queue until it has been sent to the printer (or deleted). See Windows help for information on using Print Manager.
- See and respond to messages. If the printer is not able to process and print a card, the driver displays a message on the Host PC, not the Client PC. The Host PC can see the message and view help, which provides information to resolve the situation. The title bar of the message contains the printer name. Printing for all users is suspended until the situation is resolved.
- Set values in the Printing Preferences dialog box. Values set at the Host PC apply to all users (unless changed at the Client PC). Several values can be changed at Client PCs, but those values apply only to the print jobs sent from the Client PC.
- View printer status. The Host PC runs the Printer Toolbox and all status functions. The Printer Toolbox is closed by default. To open the Printer Toolbox, choose the printer from the Windows Start menu.
- Use all features of the Printer Toolbox. The Printer Toolbox on the Host PC provides access to settings, including edge to edge settings and color controls.

Updating the Driver When Sharing Printers



For best results, follow the guidelines in this section when updating the driver for shared printers.

The 4.x Card Printer Driver now supports automatic updating from the Host PC to the Client PC. Do not delete the driver at the Client PC unless instructed to do so in this section.

If you are currently using a legacy driver

If you are currently using a legacy driver, such a version 7.x, do the following:

- 1 Record settings at the Host PC and at the Client PC so you can use them with the new driver.
- 2 Delete the printer and driver from the Client PC, and run the cleanup utility.
- 3 Delete the printer and driver from the Host PC, and run the cleanup utility.
- 4 Install the printer using the 4.x driver at the Host PC.
- 5 Set up the host for printer sharing. See "[Setting up the Host PC for Windows XP and Windows Server 2003](#)" or "[Set Up the Host PC for Printer Sharing on Windows Vista](#)".
- 6 Install the printer at the client PC. See "[Setting up the Windows XP Client PC](#)" or "[Printer Sharing for Windows 7 PCs](#)".

If you are currently using a 1.0, 2.0, 3.x, or 4.x driver

If you are currently using a 1.0, 2.0, 3.x or 4.x driver, do the following:

- 1 Record settings at the client PC and at the Host PC so you can use them with the new driver.
- 2 Make sure all cards sent to the printer have printed or been cancelled. Do not send cards to print from Client PCs or the Host PC during this procedure.
- 3 Log onto the Host PC as a user with Administrator permissions.
- 4 Insert the driver CD in the Host PC drive.
- 5 Choose "Install the Printer" from the CD menu. The driver will update at the host PC.
- 6 At the client PC, the driver will update automatically. The time required to update depends on network speed, activity at the Host and Client PCs, and other factors.
- 7 To verify that the driver at the Client PC has been updated, open the Printer Toolbox and look at the driver version.
 - Choose Start > Programs > Card Printer > Card Printer to open the Printer Toolbox.
 - View the version of the driver.



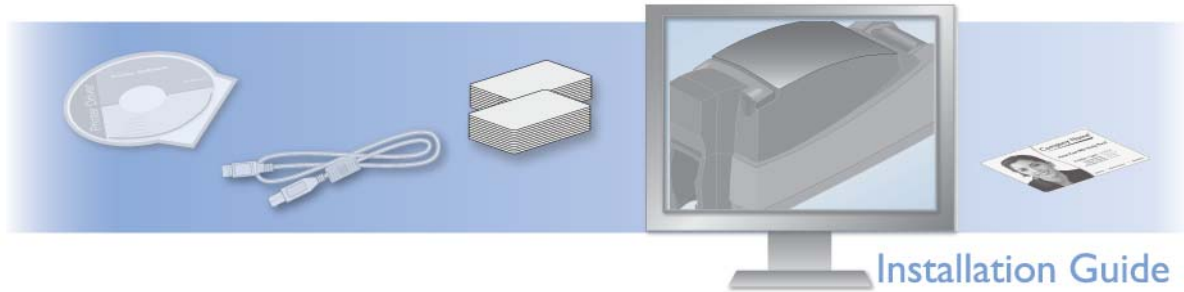

Installation on Non-Windows Platforms

This section provides information about installing the printer

- ["Open Platform Driver Installation"](#)
- ["Open Card Installation"](#)

Open Platform Driver Installation



To install the printer with the Open Platform Driver, see the *Open Platform Driver Guide*, which is available at: www.datacard.com/openplatformdriver. You can download the complete driver which includes the guide, or you can download the information. For both downloads, you must click through and accept the license agreement.

Open Card Installation



The Open Card option is available for 32-bit operating systems only. Printers with the Built-in Ethernet and Open Card option include an LCD panel, which provides access to status information and configuration settings. Printers with the Open Card option can print cards using the Open Card data format (when the Data Format is set to Open Card). The option includes a CD-ROM which contains utilities, samples, and the *Data Formatting Guide* (in PDF format).

Plan for the following installation and setup steps:

- 1 Define the requirements for the card to guide you in the installation and setup. See the *Data Formatting Guide* for details about card features supported.
- 2 If you need to change settings, such as K power, install the printer and driver on a Windows PC. You might also want to install Diagnostics for Card Printers if you will set up a custom magnetic stripe format. The Data Format must be "Printer Driver" to use the driver and Diagnostics for setup. See ["Installation on Windows"](#) for the steps to install the Card Printer Driver for Windows.
- 3 Connect the printer to a PC with Telnet to define card layouts in the printer. See *Data Formatting Guide* > Getting Started > Connecting the Printer. The Data Format must be "Open Card" to use the Telnet menus in the printer. Plan to print sample cards to verify that cards meet the requirements.
- 4 Connect the printer to the production system and configure the system to communicate with the printer. The Data Format must be "Open Card" to receive data from the host and use it to print cards.

Set the Data Format



Before you send any data to the printer, set the data format so the printer can receive the data you send.

- 1 Press the Enter key to enter the menu system.
- 2 Press the Up or Down Arrow key to scroll to “Configuration” and press the Enter key.

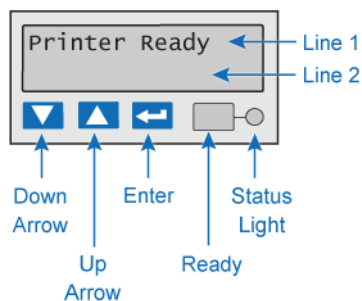

- 3 Press the Up or Down Arrow key to scroll to “Data Format” and press the Enter key.



- 4 Press the Up or Down Arrow key to display the data format you want on the second line of the display and press the Enter key.



- 5 The “Apply/Restart” prompt appears on the second line of the display. Press the Enter key to confirm the data format choice and restart the printer.

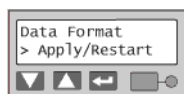

After restarting, the printer is ready to accept data in the format you have chosen.



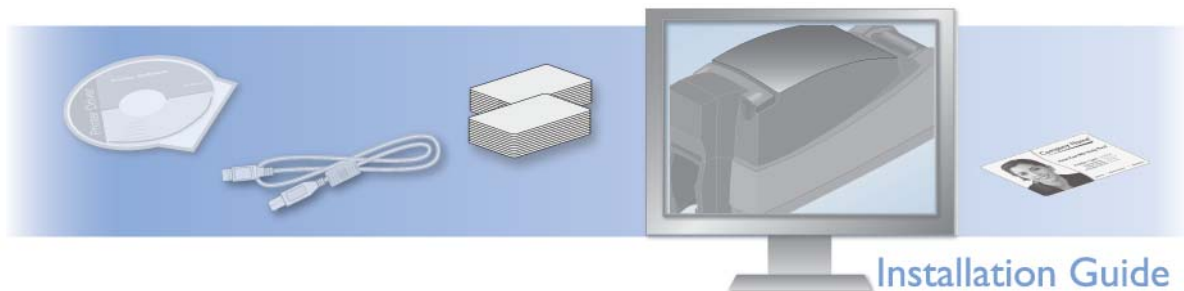

Updates, Upgrades, and More

This section describes:

- ["Updates"](#)
- ["Upgrades"](#)
- ["Deviations"](#)
- ["Removing a Printer from a Windows PC"](#)

Updates

An update replaces part of the product you have—usually software—with a newer release. Driver updates and firmware updates are the most common types of updates.

Driver Updates



Driver updates are available from the Web site or from your service provider. See *InfoCentral > Contact Us* for the Web address. Read the information about supported printer types and operating systems before installing a driver update to make sure that your printer and operating system are supported by the new driver.

If you have a printer installed and you attempt to install a new printer that uses the same driver (but a different release), you must update the driver for the existing printer before you can install the new printer (If the printers use different drivers, you will not be prompted to update.)

You can update only the same type of driver and only within the same brand.

Existing Driver	Operating System	New Driver	Update?
1.x	Windows® 2000	2.x	Yes
1.x or 2.x	Windows XP	12.x	No--remove and install the new driver
1x or 2.x	Windows Server 2003	12.x	No--remove and install the new driver
2.x	Windows 2000	None	None
3.x	Windows Vista®	12.x	Yes

Existing Driver	Operating System	New Driver	Update?
4.x or 5.x	All except Windows 2000	12.x	Yes
10.x or 11.x	All except Windows 2000	12.x	Yes
None	Windows Server 2008	4.x	No
7.x	Windows 2000	None	None
7.x	Windows Server 2003	4.x	No--remove and install the new driver
7.x	Windows XP	4.x	No--remove and install the new drier

You can update a driver using a newer driver CD or using files downloaded from the Web site.

Updating a Driver Using Downloaded Files

- 1 Prepare the printer for installation. See ["Preparing the Printer"](#) for the steps to follow.
- 2 Log on to the PC as a user with Administrator access (Windows Vista) or Administrator permissions (Windows XP).
- 3 Use Windows Explorer to locate the downloaded file. See ["Installing from Downloaded Files"](#) if you need to download the driver.
- 4 Double-click the downloaded files on the PC.
- 5 Click "Continue" on the User Account Control dialog box if it appears.
- 6 The License Agreement window appears. Click the "I accept . . ." choice and then click the "Next" button.
- 7 The Update Confirmation dialog box appears. Click "Yes" to continue.
- 8 The installation displays a "Please wait" message.
- 9 When the update is complete, one or two "Update successful" dialog boxes appear. Click "OK" as needed to continue.

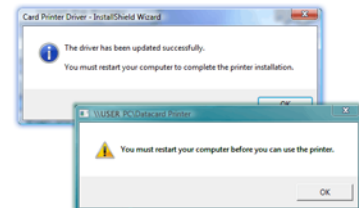
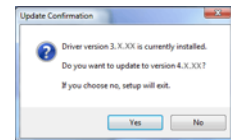

10 Restart the PC:

- a From the Start menu, choose the right-most button.



- b Choose Restart from the popup menu.

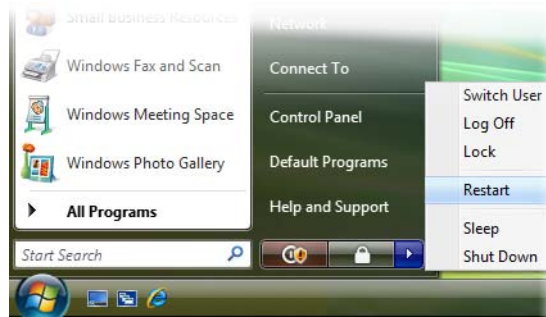

Updating a Driver Using a Driver CD

- 1 Log on to the PC as a user with Administrator access (Windows Vista) or Administrator permissions (Windows XP).
- 2 Insert the driver CD in the PC's drive. The Card Printer Driver Installation window opens.
- 3 Click the "Install the Printer" button.
- 4 On Windows Vista, the User Account Control dialog box might appear. If it does, click "Continue."
- 5 The License Agreement window appears. Click the "I accept . . ." choice and then click the "Next" button.
- 6 The Update Confirmation dialog box appears. Click "Yes" to continue.
- 7 The installation displays a "Please wait" message.



- 8 When the update is complete, one or two "Update successful" dialog boxes appear. Click "OK" as needed to continue.
- 9 Remove the CD from the PC.

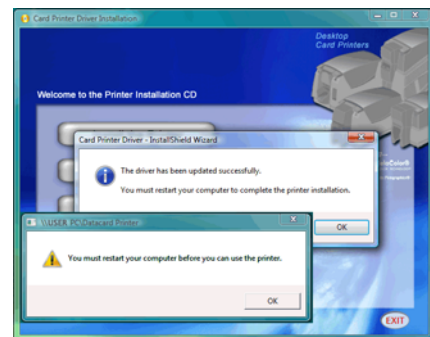
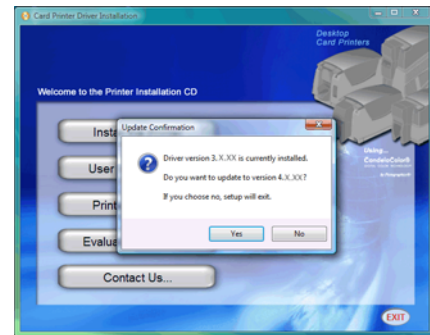

10 Restart the PC:

- a** From the Start menu, choose the right-most button.



- b** Choose "Restart" from the popup menu.

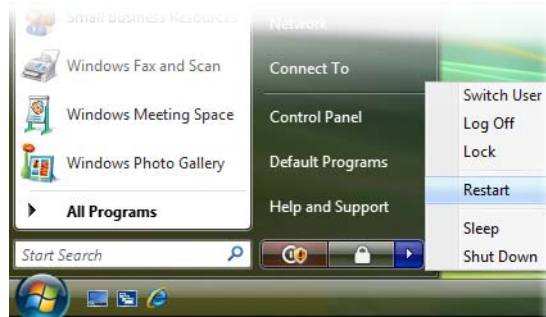

Firmware Updates



Firmware updates are sometimes available from the service Web site or the printer Web site. Firmware is usually updated using a program and a separate firmware update file. The program guides you through the update process. In most cases, you should update firmware when your service provider recommends it.

Be careful to choose a firmware file that exactly matches your printer type.

Upgrades



An upgrade adds functionality to your printer. Most often, upgrades are physical changes to the printer, performed by the service provider. Depending on the printer, the following types of upgrades might be available:

- Magnetic stripe module
- Smart card module
- High-capacity input hopper
- High-capacity output hopper

Field upgrades come with installation instructions designed for trained service providers. Instructions for using the new functionality are included in *InfoCentral > Features*.

Deviations



Deviations are specially adapted products, created as a special-order. Most often, the driver or the firmware is deviated; sometimes the hardware (printer) is also changed. If you have a deviated driver, firmware or printer, be very careful about updating the driver or firmware. A deviated driver or firmware will have a version number with “d” near the end, similar to the following:

Firmware Version: 12.11.d1

Driver Version: 4.3.d2

Always check with your service provider to determine whether to install the update. Do not update until you are sure that the update supports the special features of your product.

Deviations might be called by a different name in your organization. Other names might include RPQ, custom, or special. RPQ stands for Request for Price Quotation, which is one of the first steps in developing an agreement to create the deviated product.

Installing a Deviated 3.x Driver on Windows Vista

If you have the released 3.x driver installed on a PC running the Windows Vista operating system, and need to install a 3.x driver deviation on the PC, use the following steps:

- 1 Remove the existing driver. See ["Removing a Printer from a Windows PC"](#) for the steps to follow. Be sure to run “Uninstall Driver Software.”
- 2 Restart the printer.
- 3 Install the deviated driver.
 - For a bidirectional driver, see ["Installing from Downloaded Files"](#) for the steps to follow.
 - If the deviated driver is a unidirectional driver, see ["Installing the Unidirectional Driver"](#).
- 4 Change driver settings as needed for your card design.

Removing a Printer from a Windows PC



If you need to use an earlier version of the Windows Card Printer Driver, remove the printer and all driver files from the PC. You might also want to remove the printer and all driver files when you use the PC for another purpose or for another reason. Windows keeps an archive of drivers installed and will use those files when installing hardware that was previously installed. Removing the printer deletes those archives.

If you need to install an earlier version of the printer driver, follow these steps before beginning that installation:

- 1 Log on to the PC as a user with Administrator access.
- 2 Do one of the following to open the Printers window:
 - For Windows XP, choose Start > Settings > Printers and Faxes.
 - For Windows Server 2003 and some XP installations, choose Start > Printers and Faxes.
 - For Windows 7, Windows Vista and Windows Server 2008, choose Choose Start > Control Panel > Hardware and Sound > Printers.

- 3 Make sure all cards sent to the printer have printed. You cannot delete a printer that has jobs in the print queue.
 - a Double-click the printer to open the Print Manager window for the printer.
 - b If any jobs appear, do the following:
 - ◁ If the job is paused and you want it to print, click the job and then choose Document > Resume. Wait for the jobs to complete.
 - ◁ If you want to delete a job in the queue, click the job and then choose Document > Cancel. Click “Yes” to confirm.
 - ◁ If the printer is paused or offline, the title bar for the window will include that status. Choose Printer and clear the appropriate choice to enable printing.
 - ◁ To cancel all jobs, choose Printer > Cancel All Documents. Click “Yes” to confirm.
 - c If jobs remain in the printer queue, see the *Solutions Guide* or ask your service provider for more information.

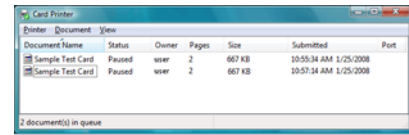

- 4 Power off the printer.
- 5 Disconnect the USB or network data cable from the printer.
- 6 Close any Windows applications that are running.
- 7 In the Printers window, click once on the printer icon to select it.

- 8 Right-click to display the popup menu.
- 9 Choose “Delete” in the popup menu to remove the printer.
- 10 Click “Yes” to confirm deletion.
- 11 If needed, click “Close” on the message box informing you that the default printer has been deleted.

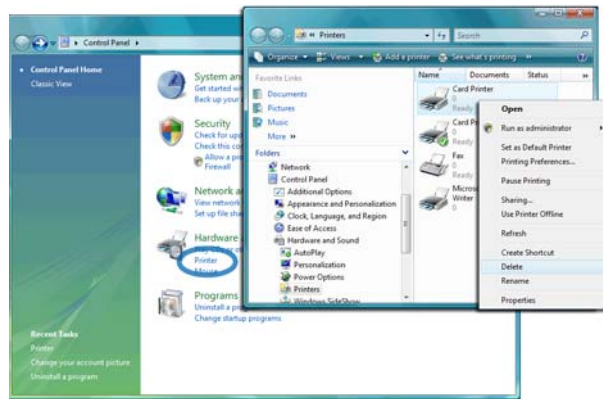

Repeat steps 2 through 10 for each card printer installed on the PC.

- 12 From the Windows task bar, choose Start > (All) Programs > Card Printers > Uninstall Driver Software.
- 13 Click “Continue” on the User Account Control dialog box if it appears.

The utility looks for installed card printers. If it finds them, it displays a prompt to delete all installed card printers before running the uninstall utility. Return to step 2 to remove additional Card Printer Drivers.

- 14 When all Card Printer Drivers have been deleted, the utility displays a prompt to click Yes to delete all driver files. Click “Yes.”

The utility deletes files and then displays a prompt.



- 15 Close all applications and then click "OK." On Windows XP and Server 2003, Windows restarts.

Other Printer Drivers

Printers using a driver version in the range of 7.4 to 7.7 used a Cleanup Utility to remove driver files, but did not delete the Windows archive. The cleanup utility, and instructions for running it, were available on the driver CD. They are also available from the Web site.

